

NAUTILUS

PORTABLE EXTRACTOR



Nautilus MX500E Operating Manual



LMANN17 Revised: 02-16-2018

TABLE OF CONTENTS

| <u><i>TOPIC</i></u> | <u><i>PAGE #</i></u> |
|---|----------------------|
| • Introduction | 3 |
| • Technical Specifications | 4 |
| • Optional Equipment | 5 |
| <u>SECTION 1: Operational Safety</u> | |
| • Electrical Safety | 6 |
| • Mechanical Safety | 7 |
| <u>SECTION 2: Operation Procedures</u> | |
| • Vacuum Connections | 8 |
| • Electrical Supply | 9 |
| • Water Supply & Chemicals | 10 |
| • Solution Hose & Pump Priming | 13 |
| • Vacuum Hose | 14 |
| • Foam Downer | 15 |
| • Pump-Out System | 16 |
| • Pressure Adjustments | 17 |
| • Shutdown Procedures | 18 |
| • Accessory Storage | 19 |
| • Troubleshooting | 20 |
| • Solution Flow Path | 23 |
| • Wiring Diagrams | 24 |
| <u>SECTION 3: Maintenance/ Technical</u> | |
| • Maintenance | 26 |
| • Drawings & Parts Lists | |
| ○ Pump | 35 |
| ○ Pressure Unloader | 36 |
| ○ Auto-Fill | 37 |
| ○ Pump-Out Pump | 39 |
| ○ Parts Pictures | 40 |
| ○ Parts List | 51 |
| ○ Hose List | 54 |
| • Warranty | 55 |

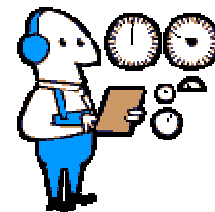

Introduction

Congratulations on your purchase of the Hydro-Force Nautilus MX500E. The MX500E is designed to give truckmount-level performance in a portable machine that combines versatility with ease of transport. Years of experience, engineering, and planning have gone into the design and manufacturing of the MX500E. We take a great deal of pride in the MX500E; our goal is no less than your complete satisfaction.

This manual will provide users with the knowledge required to operate the Nautilus MX500E safely, to understand how to properly operate and maintain the machine, and to ensure that the equipment operates at its maximum performance level.



All users must read and understand this manual completely before operating the machine.

Always maintain this manual in legible condition adjacent to the Nautilus MX500E, or place in a secure location for future reference.

Any questions pertaining to the operating or servicing of this unit should be directed to your nearest Hydro-Force distributor.

This manual is written specifically for the Nautilus MX500E portable extractor units manufactured by:

Hydro-Force
4282 South 590 West
Salt Lake City, UT 84123
801-268-2673
801-268-3856 FAX

Information in this manual is subject to change without notice and does not represent a commitment on the part of Hydro-Force or its parent or affiliated companies.

Technical Specifications

MX500E High Pressure Extractor

Height: 42-1/4" (107.32cm)
Length: 34-3/8" (87.31cm)
Width: 23-3/8" (59.37cm)
Weight: 135 lbs. (61.23kg.)
Solution Tank Capacity: 12 gallon (45.4 Liters)
Recovery Tank Capacity: 12 gallon (45.4 Liters)

Solution Pump: Pump-Tec #207 pump with 1/2 HP Motor - 0-500 psi
1.06 gpm / 4.01lpm
220V 50Hz – 3.4amps / 230V 60Hz – 2.8amps

Vacuum Motors: Two AMETEK Lamb 5.7" diameter 2-Stage – tangential discharge
Can be operated in series or parallel configuration

Pump-out Pump: FloJet 230VAC 5.0 gpm (0.75amp)
(Optional)

Power Draw: 10.03Amp wide open / 7.43Amp full load
(Add 0.75amps for units with optional Pump-Out Pump)

Standard Equipment

Vacuum Connection: 2" Barb or 2" Male Flash Cuff with 2" Male NPT

Vacuum Hose: 25' X 1-1/2" with 1-1/2" cuff & 2" cuff
2" Female Flash Cuff x 1-1/2" hose adapter

Carpet Wand: 1-1/2" SS Dual Jet S-Bend Wand – AW29

Accessory Mounting Hardware: Four 1/4-20 x 5/8" SS Screws and Washers

Pump Priming Hose: 12" x 1/4" with 1/4" male quick connect

HP Solution Hose: 25' x 1/4" with 1/4" male & female quick connects

Power Cord: 1 – 15M Extension Lead with male & female plug ends

Electrical: 5amp Pump Circuit Breaker
Internal Component Cooling Fan

Optional Features:

Auto Fill System with chemical draw:

Metering Tip Kit: 14 different tips for changing chemical dilution rate

Water Supply Hose: 50' x 3/8" with 1/4" female quick connect &
Female garden hose fitting

Auto Pump-out System:

Pump-out Hose: 50' x 3/4" with male & female garden hose fittings

Additional / Optional Equipment

- Wand Glide – Delrin
- Wand Glide – Teflon
- 18” Bottom Velcro Strap for Wand Holder
- Hy-Dry Deluxe Upholstery Tool:
- Flash Xtractor II:
- Gekko Handle Assembly:
- Gekko 4” Tool Head:
- SX-7 Tool Head:
- Gekko Hand Tool:
- 1-1/2” Vacuum Hose: (Sold per foot – No cuffs)
- 2” cuff for 1-1/2” Vac Hose:
- 1-1/2” cuff for 1-1/2” Vac Hose:
- 1-1/2” Hose Connector PVC:
- HP Solution Hose 1/4” X 25’ w/M-F Quick Connects
- 1/4” Male Quick Connect:
- 1/4” Female Quick Connect:
- Pump-out Hose:
- Hydro Filter II:
- Replacement Screen for Hydro-Filter II:
- Metering Tip Kit:
- Belt Pack

- AW529D
- AW529T
- NM5841
- AW50D
- AC002
- AR51A
- AR51D
- AR51G
- AR53
- AH36
- AH46
- AH42
- AH74
- AH79D
- AH102B
- AH101B
- AH65
- AC10
- AC10C
- PDE001
- AX108



AW50D



AX108



AC10



AC002

AR51G



AR51A



AR51D



AR53



Safety

⚠️ WARNING

This machine is an electrical appliance.

Care must be taken to reduce the risk of electrical shock.

READ AND UNDERSTAND ALL INSTRUCTIONS BEFORE OPERATING THE MX500E.

- To reduce the risk of property damage or injury, repairs to electrical systems should only be performed by experienced technicians. Contact your distributor for assistance. Unplug machine power cord from outlet before performing any repairs on the extractor.
- This machine shall be grounded while in use to protect the operator from electric shock. The machine is provided with a three-conductor cord and a three-contact grounding type attachment plug to fit the proper grounding type receptacle. The green and yellow conductor in the cord is the grounding wire. Never connect this wire to other than the grounding pin of the attachment plug.
- This machine is for use on a nominal 240-volt circuit and has a grounding plug that resembles the plug illustrated in the sketch to the right. Make sure that the machine is connected to an outlet having the same configuration as the plug. No plug adapter should be used with this machine.
- The power cord supplied with this machine is properly sized to handle the electrical load of this machine and properly grounded as described above. Any extension cords used with this machine must be similarly sized with an equal or greater load rating and grounded to assure safe operation.
- The power cord must be plugged into a 10amp circuit during operation.
- Do not use the MX-500E outdoors, in standing water or on wet surfaces. Do not store the MX-500E in wet conditions. If extractor is leaking, unplug machine power cords from outlets before approaching or touching machine.
- Do not unplug power cord by pulling on the cord. Grasp the plug end when unplugging the cord. Do not pull the extractor by the cord. If cord or plug is damaged, do not use cord. Replace with new cord or repair as needed before use.
- Overloaded circuit may not always trip circuit breaker. Reduced voltage to a machine on an overloaded circuit will prevent components from operating properly.

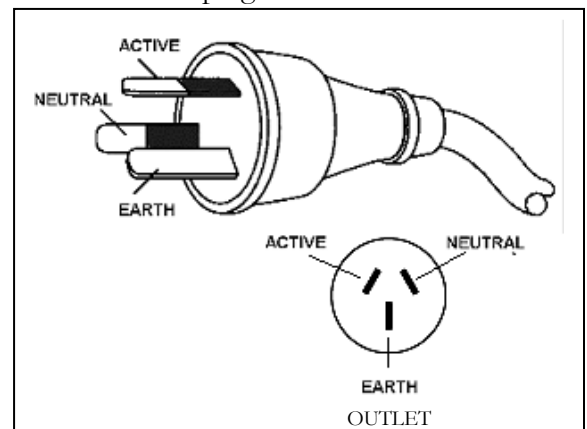

NOTICE

This machine must be protected from conditions which may damage the pump, tank, hoses and other components.

- **Freezing of water in this machine will cause serious damage.** The Nautilus MX-500E, solution hoses, and tools must be protected from freezing temperature. Store, transport, and use this equipment only in temperatures well above freezing. (32°F or 0°C). If you suspect the Nautilus MX-500E has been frozen, do not plug in or turn on machine until you are sure it has thawed completely.
- If the equipment cannot be stored or transported in a warm environment, it can be guarded from freezing by running an anti-freeze solution through the incoming water lines, chemical feed system, solution pump, solution lines, tools and pump-out pump. The machine is filled at the factory with anti-freeze to eliminate damage during shipment in cold weather.
 - The anti-freeze solution must be completely flushed from the machine before it is returned to service.
- The MX-500E must not be used to pick up flammable or combustible materials or used in areas where these materials may be present.
- Solvent-based or water-based solutions containing solvents may damage the pump, hoses, and other components. Do not assume chemical compatibility. Contact your distributor or Hydro-Force if you have questions regarding the compatibility of your chemicals with the machine.
- Do not clean with solutions that are at temperatures above 130°F or 54°C.
- Rinse the solution tank, chemical system, and pump with fresh water after each day's use.
- Do not allow pump to run dry. Always maintain adequate solution level to supply solution pump.
- HP hoses may rupture if worn or damaged. Do not use HP solution hoses if hose covering is cut, bulging, or otherwise damaged. Examine HP solution hoses daily and replace or repair hoses as needed.
- Use a Hydro-Filter II and clean the recovery tank daily to keep pump-out filter and pump from becoming clogged. Store the Nautilus MX-500E with the recovery tank lid open.
- Keep Vacuum Inlet Filter clean and check float for proper operation. Do not operate the Nautilus MX-500E without the Vacuum Inlet Filter in place. **Use defoamer to eliminate foam build-up during cleaning and prevent foam/moisture from entering vacuums.**

⚠ WARNING

Use common sense to protect yourself and others while using this equipment.

- Keep pets and children away from the machine when in use.
- Keep all body parts, hair, and loose clothing away from openings and moving parts. Always wear appropriate work clothing and safety equipment when operating unit.
- Use extra care when cleaning on stairs. Wet carpet on stairs can be slippery.
- Do not move the MX500E up or down stairs when tanks are full of water. Drain solution and recovery tanks, and secure base latches before moving unit up or down stairs. Lift using only the machine handles designed & designated for moving and lifting.
- Water may be spilled, drip, or be exhausted from vacuums during operation. Place unit in area where water will not cause damage or use drop cloth to protect surfaces.

Vacuum Connections

The MX500E has a unique vacuum system which allows you to connect your vacuums in either parallel or in series. Vacuum connections can be changed quickly, with only a screw driver.

* **THIS MUST BE PERFORMED BY A QUALIFIED TECHNICIAN**

While there is debate on which vacuum alignment provides the best extraction, this much is true:

- Two vacuums in series: The vacuum lift is increased by 1.6 times the rating of a single vacuum, while the air flow stays the same as a single vacuum.
- Two vacuums in parallel: The vacuum air flow is increased by 2.0 times the rating of a single vacuum, while the lift stays the same.

Air flow is usually measured in cubic feet per minute, indicated as CFM.

Lift is usually measured in inches of water column, indicated as "H₂O or "WC.

To connect vacuums in parallel:

1. Connect the discharge / exhaust hose from vacuum #1 to the exhaust pipe on machine base.
2. Place the rubber stopper into the vacuum inlet port of vacuum manifold number two.
3. Open vacuum gate valve and attach the Gatekeeper to prevent accidental valve closure.

When connected in parallel, both vacuums must be running during cleaning. Vacuums cannot be operated individually.

To connect vacuums in series:

1. Connect the discharge / exhaust hose from vacuum #1 to the vacuum inlet port of vacuum manifold number two.
2. Place rubber stopper into the exhaust pipe on machine base.
3. Remove Gatekeeper and close vacuum gate valve.

When connected in series vacuums can be operated individually if desired during cleaning.

NOTICE Always secure the Gate Valve Open with the Gatekeeper when connecting the vacuums in Parallel. Closing the Vacuum Gate Valve with the hoses connected in the Parallel configuration may cause damage to Vacuum #2.

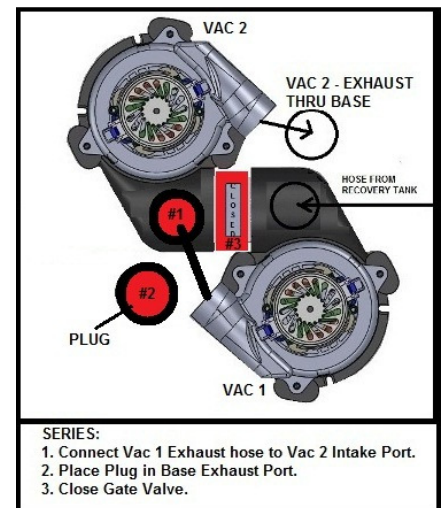
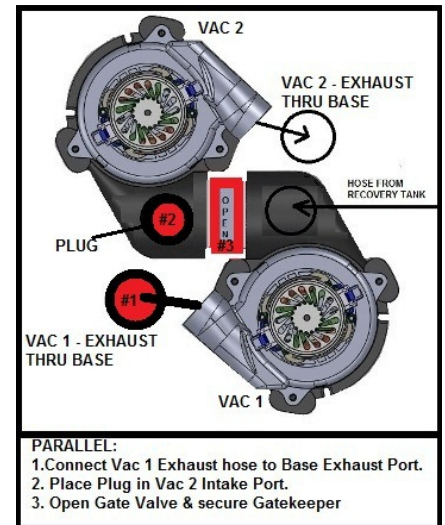

GATEKEEPER

Operation Procedures

Knowledge of the proper operation of the MX500E is required to ensure user safety and efficient performance of the extractor.

SET UP AND OPERATION

1. Electrical Cords:

The MX500E can be operated on a single 220/230 volt 10amp circuit.

An overloaded circuit will not always trip the circuit breaker immediately, but may not provide sufficient voltage for proper operation and the breaker may trip eventually.

One 15M extension cord is supplied with the Nautilus MX500E. Plug the power cord into an outlet with sufficient voltage and an amp rating for the power demands of the MX500E, connect the cord to the MX500E and then proceed with your set-up.

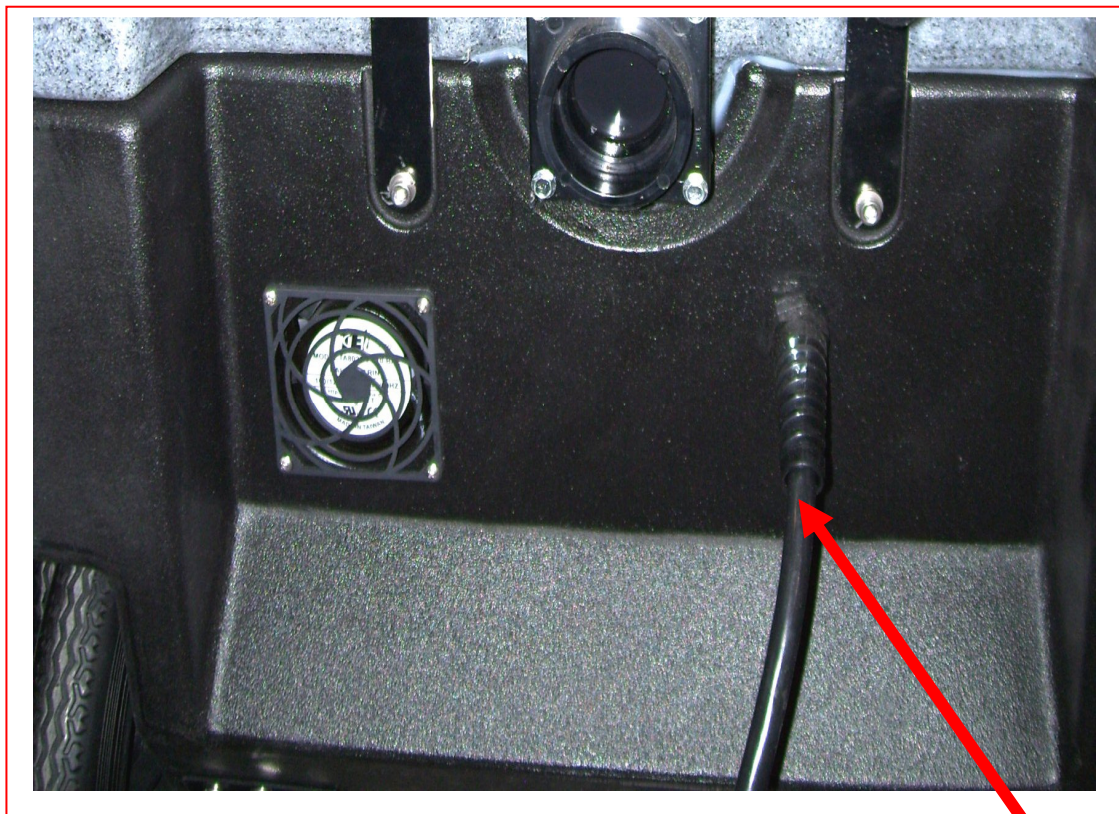

Power Cord Connection

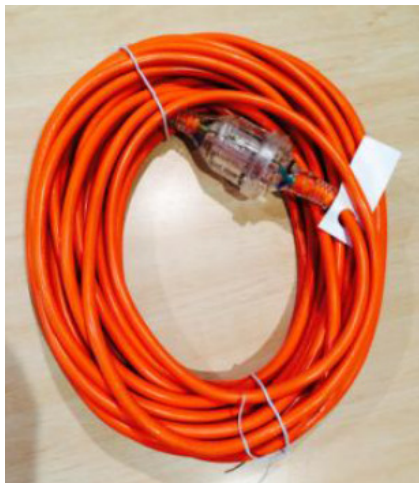

**EXTENSION CORD:
#CSRCE1515
15M – 1.5M2 3-GAUGE
M-F PLUGS**

2A. Water Supply & Chemical Mixing– Manual Fill:

- Pour up to **12 gallons (45.4 Liters)** of hot water into the solution tank at the front of the machine. **The water temperature cannot exceed 130°F or 54°C.**
- Measure and add the appropriate amount of the desired liquid chemical to the water in the solution tank. The amount of chemical will vary depending on the type of chemical used, the amount of water in the tank, and the material being cleaned; consult the chemical packaging for specific mixture ratios.
- Powdered chemicals should be dissolved in water before adding to the water in the solution tank.

NOTICE **DO NOT RUN OUT OF WATER WHILE USING THE MACHINE!** Ensure that the tank contains enough water to complete each job. If the water level is low: stop cleaning, turn off the pump, and refill the tank. Running the pump dry will damage the pump and void the warranty.



Pour appropriate amount of hot water into solution tank

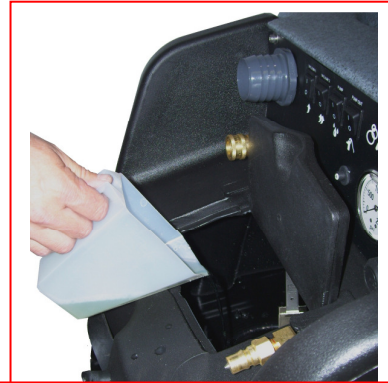

Add appropriate amount of chemical to water in solution tank

2B. Optional Auto-Fill System - Water Supply & Chemical Dilution:

- The chemical dilution rate is controlled by the metering tip, and the dilution rate can only be changed by changing the metering tip (See “How to Change the Metering Tip” on Page 11 for instructions.)

Chemical Feed Setup:

- Remove the chemical feed hose from the solution tank. Make sure float is attached to valve and hanging freely, above the bottom of the solution tank. Adjust float height to maintain adequate water level.
- Place the end of the chemical feed hose into a container of liquid chemical.
- If the tip is removed, and the proportioning system operated with no tip, the dilution rate will be 8:1, the equivalent to adding 16-1/4oz of chemical to each gallon of water. (125 ml per liter of water)
- The recommended tip for use with the MX500E is the turquoise tip with a dilution rate of 256:1. This means that for each gallon of water flowing into the machine, 1/2 ounce of chemical will be added. (3.91ml of chemical per liter of water)

If a fresh water rinse with no chemical is desired, simply leave the chemical feed hose inside the solution tank.

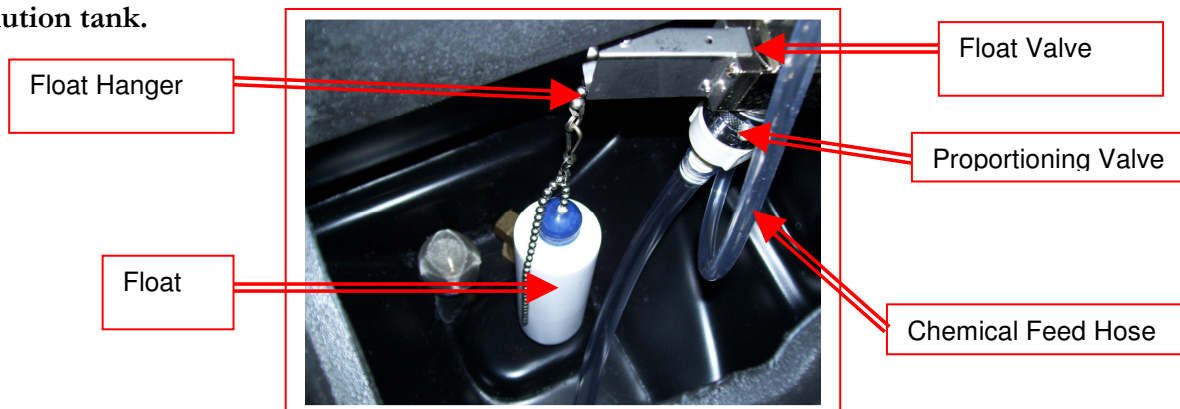

How to Change the Metering Tip:

- Remove the chemical feed hose from the barb on the side of the proportioning valve.
- Unscrew and remove the old tip.
- Screw in the proper tip for your chemical tip and place the hose back on the barb

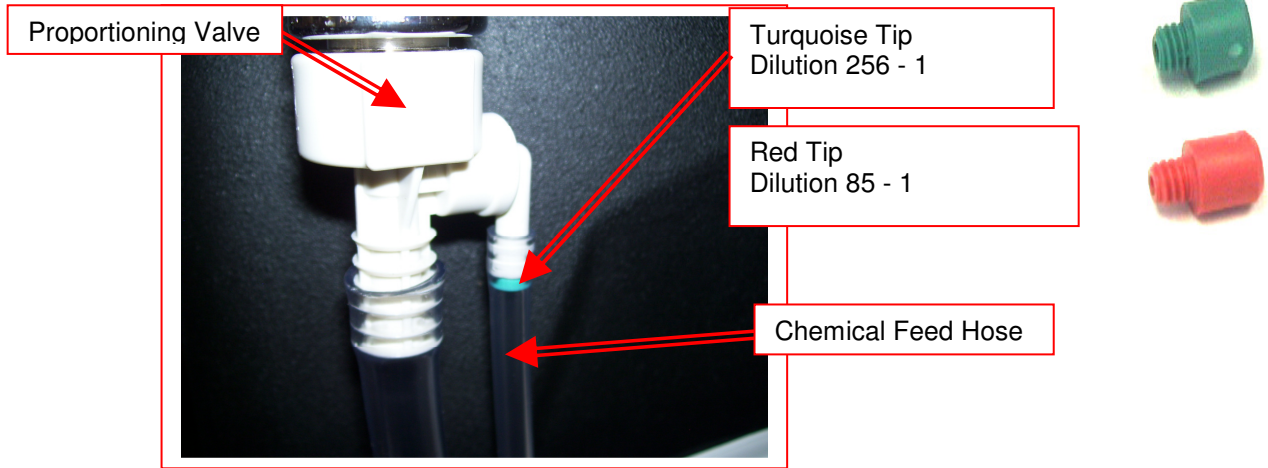

Metering Tip Kit (Hydro-Force Item# PDE001) contains 14 different colored metering tips, allowing dilution rates from 11:1 up to 427:1. Refer to the chart below to select the tip that meets the dilution rate for your chemical application.

- For example: if you require 1-1/2 ounces of chemical per gallon of water, change to the red metering tip with the dilution rate of 85:1. (11.77ml of chemical per liter of water)
- The dilution rates are based on chemicals with water-like viscosity. Thicker (more viscous) chemicals will dilute at a different rate.
- For powdered chemicals, a liquid concentrate must be made. Mix the concentrate according to the manufacturer’s directions, and then select the appropriate metering tip.
- Contact your distributor or Hydro-Force if you have questions about your chemical.

Metering Tip Application Chart:



Metering Tip Kit – PDE001

| TIP COLOR | CHEMICAL DILUTION RATES | | RATES ml / liter |
|------------------|-------------------------|----------------|------------------|
| | OZ / GAL | (RATIO) | |
| TAN | 0.30 | (427:1) | 2.34 |
| ORANGE | 0.40 | (320:1) | 3.13 |
| TURQUOISE | 0.50 | (256:1) | 3.91 |
| PINK | 0.75 | (170:1) | 5.88 |
| LIGHT BLUE | 1.00 | (128:1) | 7.81 |
| BROWN | 1.12 | (114:1) | 8.77 |
| RED | 1.50 | (85:1) | 11.77 |
| WHITE | 1.75 | (73:1) | 13.70 |
| GREEN | 2.00 | (64:1) | 15.63 |
| BLUE | 2.50 | (51:1) | 19.60 |
| YELLOW | 3.75 | (34:1) | 29.41 |
| BLACK | 5.00 | (26:1) | 38.46 |
| PURPLE | 8.50 | (15:1) | 66.67 |
| GRAY | 11.50 | (11:1) | 90.90 |
| NO TIP | 16.25 | (8:1) | 125.00 |

Water Supply:

- Once the correct metering tip is in place:
 - Connect the Auto-Fill Water Supply Hose to the water inlet (the male quick-connect on the front of the machine.)
 - Connect the other end of the hose to a water faucet, and then turn on the water.
- Hot water can be used as long as the temperature does not exceed 130°F or 54°C.
- Faucet adapter kits (Hydro-Force item #AX21 & AX22) are available that allow connection to different types of faucets if needed.



Connect the Auto-Fill Water Supply Hose to a faucet and turn on the water



Connect the Auto-Fill Water Supply Hose to Solution Inlet (Male quick connect on the front of the machine.)

3/8" id X 25' with F Quick Connect & F Garden Hose Fitting

Chemical Feed Hose



Float Valve

To adjust the water level in the solution tank:

- Turn off the water supply.
- Adjust the length of the chain connecting the float bottle to the float valve. Unhook the float from the beaded chain on the valve. Unsnap the hook from the beaded chain on the float.
 - Move the bottle down to decrease the water level.
 - Move the bottle up to increase the water level.
- Snap the back onto the float chain & hook the float back onto the valve chain.
- Turn the water supply back on.

If the chemical is not drawing, or if the tank is not filling or is overflowing, refer to the trouble shooting guide, or contact your distributor for assistance.

Float Hanger Hook

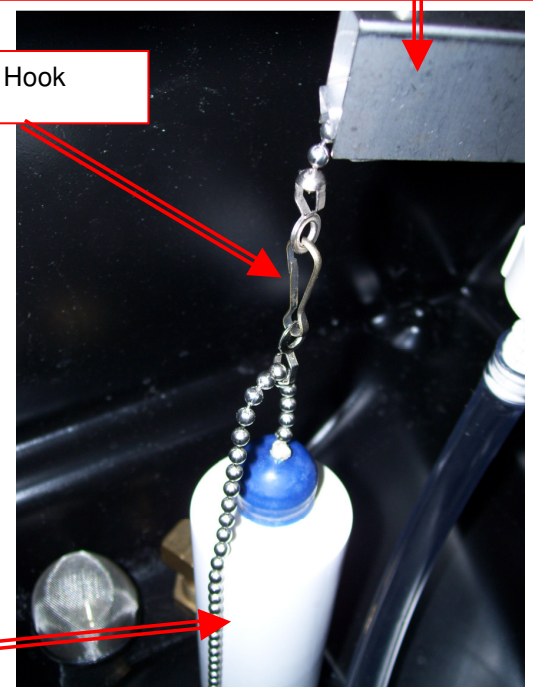

Float Bottle

3. Priming the High-Pressure Pump:

Once water is in the solution tank, the high pressure pump must be primed:

- There is a priming hose included with the machine. Connect the priming hose to the solution outlet – female quick connect on the front of the machine.
- Turn on both vacuums and the solution pump. Insert the end of the priming hose into the vacuum inlet port on the front of the machine and cup your hand around the hose to block off the vacuum inlet with your hand. The vacuum will pull solution through the pump and priming hose into the vacuum tank.
- Turn off the pump and then the vacuums. Disconnect the priming hose. You can now continue your set-up. As long as there is solution in the tank, the pump should remain primed.

If the pump still does not prime, or if flow is low or unsteady, check the hose from the solution tank to the pump (as well as the filter) for clogging, kinks, or restrictions. Clean or replace hose and/or filter and repeat the priming procedure.

If you are having trouble with the pump, refer to the trouble shooting guide or contact your distributor for advice or assistance.

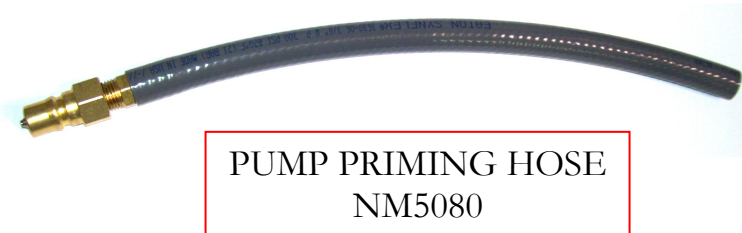

4. Connection of Solution Hose:

Connect the high pressure solution hose to the solution outlet (female quick connect on the front of the machine). Connect the other end of the hose to the male quick connect on the cleaning tool. When you are ready to start cleaning, turn the solution pump switch to the ON position. The pressure is preset, there is no pressure adjustment to be made.



HP Solution Hose Assembly – AH79D
1/4" id X 25' with M-F Quick Connects

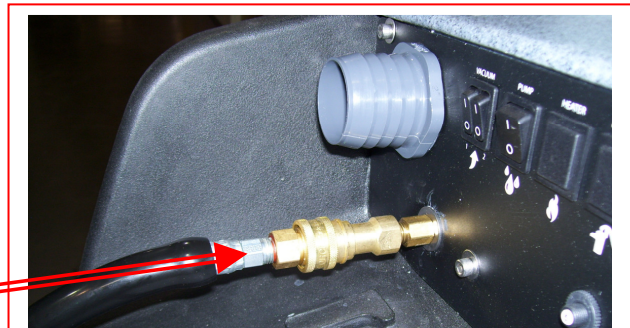

Connect the male end of the HP Solution Hose Assembly to the female solution outlet fitting on the machine. Connect the female end to the cleaning tool.

5. Connection of Vacuum Hoses:

The vacuum connection port on the machine can be either a 2" hose barb or 2" male Flash Cuff. Both are included with your MX500E. The desired connector can be threaded into the vacuum port on the front of the machine.

A 2" female Flash Cuff 1-1/2" hose adapter is also included to connect the 1-1/2" vacuum hose to the 2" male Flash Cuff on the machine.

A 2" hose cuff for 1-1/2" vacuum hose is included to connect the 1-1/2" vacuum hose to the 2" hose barb on the machine.

With the proper cuff attached to the 25' Vacuum Hose, the 25' vacuum hose is then connected to the vacuum connection port on the MX500E. The other end with the 1-1/2" cuff is connected to the cleaning tool.

When ready to begin cleaning, turn both vacuum switches to the ON position. If connected in series, the MX500E can be operated with only one vacuum for cleaning delicate fabrics. (See Vacuum Connection instructions on Page 8) In most situations you will turn both vacuum switches ON.



Vacuum Connection with standard barb and vinyl cuff



Vacuum Connection with Flash Cuffs

6. Optional Foam Downer:

A key problem with portable extractors is that they have small tanks where foam dissipates slowly. If you have had issues with foam or are anticipating foaming problems, you will want to use a Foam Downer.

Foam can be drawn into the vacuums before the vacuum shutoff closes. Foam and water blowing out the vacuum makes a big mess, can decrease vacuum lift and damage the vacuum motors.

The Foam Downer kills foam as waste water enters the machine. Place a container of liquid defoamer on the top of your MX500E. The vacuum air flow siphons the liquid defoamer through Foam Downer into the vacuum tank, breaking down the foam before it can cause any damage or make a mess.

- Mounts and is ready to use in seconds
- Uses defoamer very economically
- NO LABOR is involved to spray or spread defoamer – it's all automatic
- Keeps silicone defoamers off the floor where they can cause resoiling problems

The Foam Downer is an attachment that allows the vacuum to draw a small amount of defoamer in a constant slow flow into the waste tank of the Nautilus. We recommend using a diluted defoaming solution of four ounces of defoamer to one gallon of water (1-32) or 31.25ml per liter. Place the draw tube into the gallon of diluted defoamer and open the needle valve one half turn as your starting point. If this is not sufficient to break down the foam you can open the valve more or add more defoamer to the water to make a stronger solution.

With the valve open one half turn it will take approximately one half hour to drain the gallon of diluted defoaming solution.

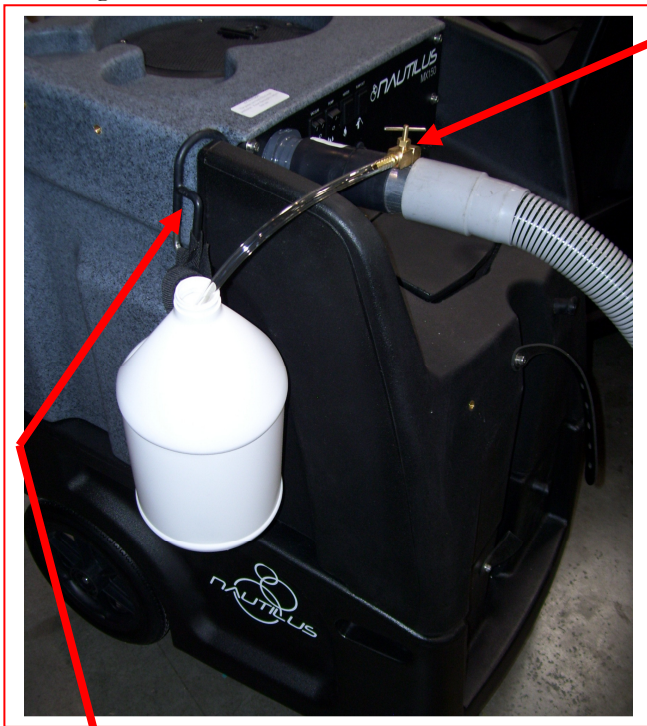

FOAM
DOWNER

AH17



FOAM DOWNER cannot be used with 2" Male Flash Cuff connector on machine. Remove 2" Male Flash Cuff and install 2" hose barb as needed.

HOSE HOOK
AH95



7. Connection of Optional Pump-Out Hose:

If your machine has the Optional Auto Pump-Out System you may want to connect the Pump-Out Hose. The pump-out hose is a 50' section of 3/4" garden hose. (Use of smaller diameter hose may reduce flow.)

- Remove the cap from the pump-out outlet fitting on the back of the machine.
- Connect the pump-out hose to the outlet fitting.
- Place the other end of the hose in a commode or drain connected to the sanitary sewer system.
- Secure hose end to prevent movement during pumping.

NOTICE

- Use defoamer to prevent foam build-up in recovery tank during cleaning and to keep foam/moisture from entering vacuums.
- Use Hydro Filter II inline filter to trap and remove debris from the waste water before it enters the recovery tank. Excess debris in recovery tank may clog Pump-Out filter. Clean Filter as needed during use.
- Do not turn the Waste Pump switch ON unless pump-out hose is connected and has been routed to a proper drain.
- The Waste Pump does not use a float switch and will run as soon as the Waste Pump switch is turned ON. It is made to run continuously while cleaning, as this type diaphragm pump can run dry without damage.

When ready to begin cleaning, turn the Waste Pump switch to the ON position.

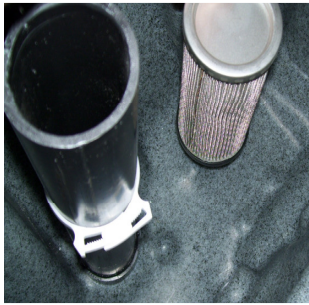

Pump-out Filter

Connect the Female Garden Hose Fitting end of the Pump-out Hose to the outlet fitting on the back of the recovery tank. Place the other end of the pump-out hose in a sanitary drain.

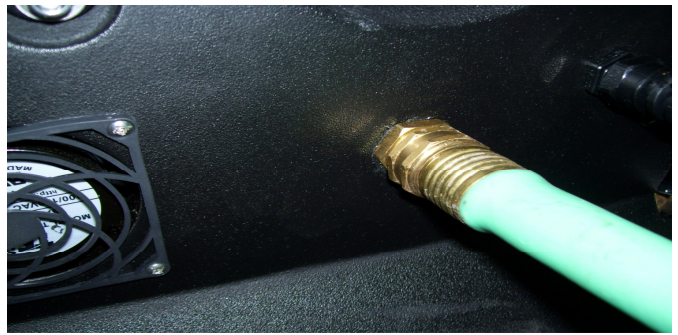

If not using the waste pump-out, the pump-out hose does not need to be connected. When the recovery tank fills during cleaning, the float assembly in the vacuum inlet filter will rise and will automatically shut off the vacuum air flow to prevent the recovery tank from overflowing and waste water from getting into the vacuums. When this occurs:

- Immediately shut off the vacuum switches.
- Drain the recovery tank.
 - Turn off the pump switch while draining the tank.
 - Turn pump switch back upon resumption of cleaning.
- Close the drain valve and turn the vacuum switches back on when ready to resume cleaning.

If the pump-out or vacuum shutoff is not working properly, refer to the trouble shooting guide or contact your distributor for advice or assistance.



Float Shutoff Assembly



Draining the Recovery Tank

8. Pressure Adjustment:

To make it easier to check and adjust the pressure, the pressure gauge and the pressure regulator are mounted on the control panel on the front of the machine. When the high-pressure solution pump is on and primed, pressure will show on the gauge.

- To decrease the pressure, turn the brass knob on the pressure regulator to the left (counter-clockwise.)
- To increase the pressure, turn the brass knob on the pressure regulator to the right (clockwise.)
- To adjust pressure to your tool and surface requirements:
 - Check the pressure on the gauge.
 - Re-adjust as needed to set the machine at the desired pressure.
 - Choose the pressure setting that best meets your type of cleaning.

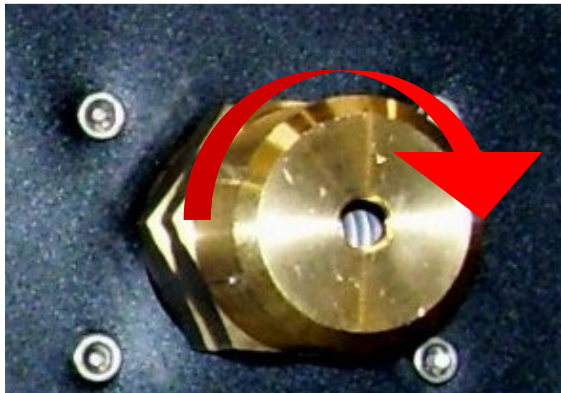

To increase the solution pressure, turn the regulator knob clockwise.

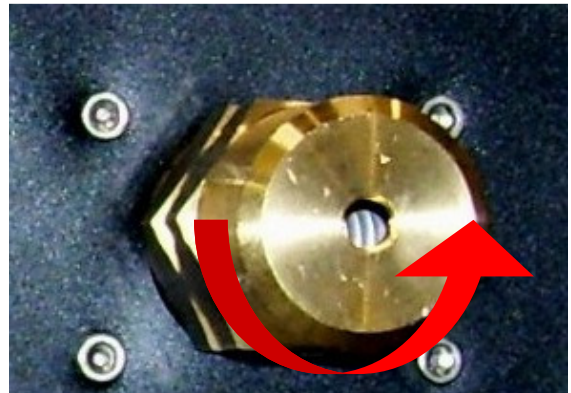

To decrease the solution pressure, turn the regulator knob counter-clockwise.

The maximum pressure setting is 500psi; however, the highest pressure attained is dependent on the amount of water flow at the tool:

- Smaller jets and lower flow will allow for higher pressure at the tool.
- Larger jets and higher flow will lower the maximum pressure attained at the tool.

The desired setting will depend on the type of cleaning and tool used. For example:

- Carpet Cleaning with 2-jet AW29 wand: 400psi
- Upholstery Cleaning with AW50D tool: 200psi

If adjusting or maintaining pressure becomes a problem, refer to the trouble shooting guide or contact your distributor for advice or assistance.

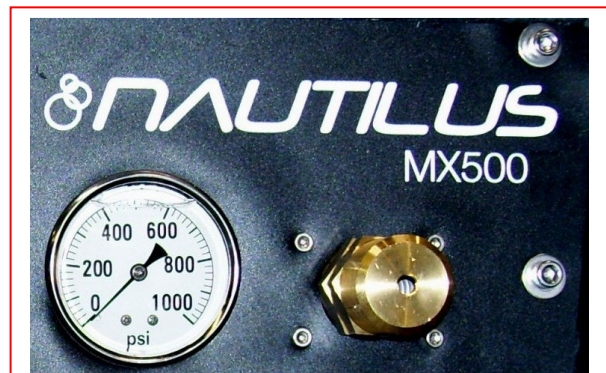

Pressure gauge & Regulator/Unloader

Shutdown Procedures:

- If using the optional auto-fill system, turn the water supply off before finishing each job. This will allow use of the water and chemical already in the tank, and will reduce the amount of excess water to be disposed of later.
- When finished cleaning, turn off all switches.
- If the optional auto-fill system was used and there is still water in the solution tank, push the float down to release the water inlet hose pressure before disconnecting the hose from the faucet. Disconnect the water inlet hose from the quick-connect on the front of the machine.
- Disconnect the solution hose and vacuum hose from the cleaning tool. Pull valve trigger to release pressure from the hose before disconnecting solution hose from cleaning tool.
- If a Hydro Filter II inline filter was used, disconnect the Hydro-Filter II from the vacuum hoses and clean the filter as needed. Replacement filter screens are available (AC10C.)
- Disconnect the vacuum hose and solution hose from the machine.
- If water remains in the solution tank, use the vacuum hose and vacuum the excess water from the tank.
- If the optional auto-fill system was utilized, place the chemical feed hose back into the solution tank.
- If the optional Auto waste pump-out system was used:
 - Turn the waste pump switch “on” to pump out any remaining water from the recovery tank.
 - Turn switch off, remove the pump-out hose from the outlet fitting and replace the cap.
 - Roll up hose toward drain to remove remaining water from hose.
 - Connect ends of hose together to prevent dirty water from dripping from hose during transport.
- Disconnect the power cords from the outlets and from the machine.
- Remove the float shutoff assembly from the recovery tank and clean vacuum shutoff filter as needed. Clean Pump-Out filter screen. Replace shutoff assembly and tank lid.
- Drain any remaining water from the recovery tank and dispose in sanitary drain. Do not use the same bucket to drain the tank that you use to fill the tank.
- Roll up all hoses and cords. Collect and store extractor, all tools, and accessories.



Accessory Storage Options:

The MX500E is designed to make it easier for the operator to transport the machine and the most common cleaning accessories.

Bucket & Sprayer Storage

The top of the MX500E is sized and recessed to hold a five gallon bucket or two one-gallon chemical bottles as well as two 2QT sprayers.

Power Cord Storage

The back of the MX500E has two sets of cord wraps to hold two 12/3 x 25' power cords.

Carpet Wand Storage

The front of the MX500E is designed to hold an S-Bend Carpet wand and has two straps to hold it securely. Optional strap for larger wands available.

Other Tool & Hose Storage

Each side of the MX500E has a set of molded in threaded inserts to which holders can be attached to hold other accessories or supplies making it much easier to move around. Four 1/4-20 x 5/8" mounting screws & washers included.

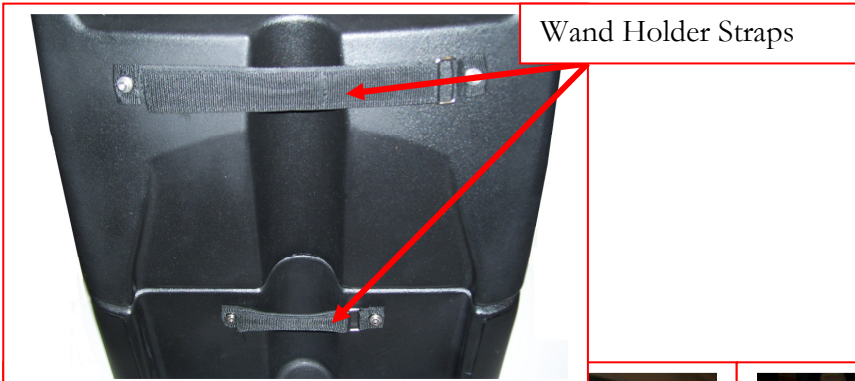

Molded in Threaded Inserts for Side Mount Holders

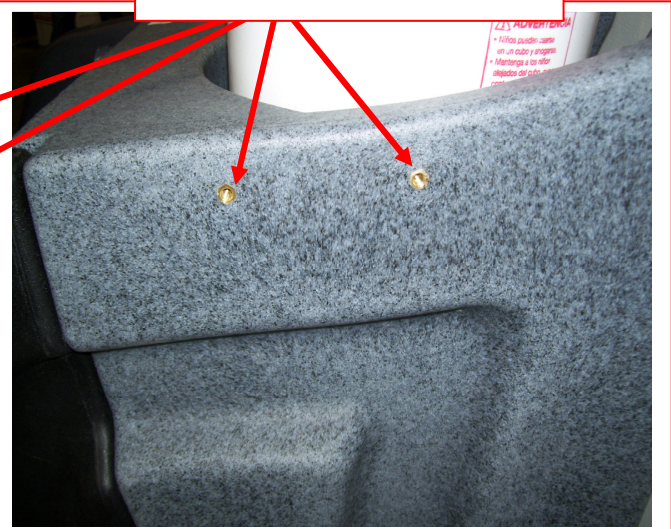

Troubleshooting

Troubleshooting – Nautilus MX500E

| Problem | Cause | Solution |
|---|---------------------------------------|---|
| Machine not turning on - No power | Building circuit breaker tripped. | Reset breakers or move cords to other outlets |
| | Faulty power cord | Replace cord |
| | Faulty switches or internal wiring | Check wiring & test switches - Repair as needed * |
| Solution Pump not running | Building circuit breaker tripped. | Reset breakers or move cords to other outlets |
| | Pump circuit breaker tripped | Reset breaker – Check available circuit power & pump |
| | Faulty power cord | Replace cord |
| | Faulty switches or internal wiring | Check wiring & test switches - Repair as needed * |
| | Pump motor breaker tripped | Push in reset button on pump motor &/or external breaker |
| | Pump motor faulty | Replace pump motor (PT066) |
| | Pump seized - trips breaker | Repair or replace pump head & bearing (PT065) - Check motor and/or replace complete pump & motor assy. (AP52) |
| Low Solution Pressure and/or Pulsation | Jets too large for pressure desired | Check jets size & flow rates use smaller jets or lower pressure |
| | Jets worn allowing too much flow | Replace jets |
| | Solution inlet filter plugged | Clean or replace filter |
| | Hose from solution tank restricted | Repair or replace hose |
| | Pump intake hose or fittings leaking | Repair or replace hose. Tighten clamps or replace fittings |
| | Pressure regulator sticking | Lube o-rings on regulator piston – PAGE 33 |
| | Pressure regulator faulty | Repair or replace pressure regulator (PT021) |
| | Filter screen or jets plugged on tool | Clean out filter or jets |
| | Solution tank empty | Add water to tank - Check & repair auto fill assembly |
| | Pump not primed | Perform pump priming procedure |
| | Pump faulty | Repair or replace pump (PT065 or AP52) |
| | Tool valve faulty | Repair or replace valve |
| | Quick connects or hoses restricted | Clean out or replace quick connects and/or hoses |
| Can't connect solution hose to machine | Pressure in lines | Release pressure |
| | Quick connects faulty | Replace quick connects (AH101B, AH102B) |
| | Wrong style/size quick connects | Replace quick connects to match connects on machine |
| <p>⚠️WARNING: To reduce the risk of fire electrical shock or injury repairs to wiring should only be performed by experienced service technicians.</p> <p>* If you are not experienced in checking electrical wiring contact your nearest authorized service center to perform tests and repairs to wiring and switches.</p> | | |

| Problem | Cause | Solution |
|---|------------------------------------|--|
| Pump-out not working | Building circuit breaker tripped. | Reset breaker or move cord to another outlet |
| | Faulty power cord | Replace cord (1696-6412) |
| | Faulty switches or internal wiring | Check wiring & test switch - Repair as needed * (NM5714) |
| | Pump-out pump faulty | Replace pump-out pump (AP37F) |
| | Pump-out filter clogged | Clean pump-out filter - Keep recovery tank clean – Use Hydro-Filter AC10 |
| | Discharge hose restricted | Un-kink, clean out or replace hose |
| | Pump-out pump clogged | Remove and clean out pump |
| Vacuum Motor not running | Building circuit breaker tripped. | Reset breakers or move cords to other outlets |
| | Faulty power cord | Replace cord (1696-6412) |
| | Faulty switches or internal wiring | Check wiring & test switches - Repair as needed * |
| | Vacuum motor faulty | Replace vacuum motor (AV012) |
| Loss of Vacuum | Vacuum motor faulty | Replace vacuum motor (AV012) |
| | Vacuum motor gasket damaged | Replace gasket (PA010A) |
| | Recovery tank lid gasket damaged | Replace lid or gasket (1650-5695 or 1663-5397) |
| | Drain valve open | Close valve |
| | Drain valve leaking | Repair or replace drain valve (PEA11) |
| | Vacuum motor hoses loose / leaking | Reconnect or replace vacuum motor hoses |
| | Vacuum Valve in wrong Position | Check Vacuum Gate Valve Position. – PAGE 8 |
| | Vacuums not connected properly | See vacuum connection instructions – PAGE 8 |
| | Vacuum hose or tool clogged | Clean out vacuum hoses and tool |
| | Vacuum hoses or cuffs leaking | Replace vacuum hoses, cuffs & connectors as needed |
| | Recovery tank full | Drain tank |
| | Float shutoff filter clogged | Clean float shutoff filter |
| | Float stuck in float shutoff | Repair or replace float shutoff |
| | Pump-out Pump faulty | Repair or replace pump out pump (AP37F) |
| Recovery tank damaged | Replace recovery tank | |
| Chemical not feeding | Solution tank not filling | Check & repair auto fill assembly |
| | Chemical hose restricted | Un-kink, shorten, clean out or replace hose |
| | Filter screen plugged | Clean or replace filter (PDE100-11P) |
| | Low Incoming Water Pressure | Move bottle & shorten chemical hose to improve draw – Find other water source. |
| | Wrong size metering tip | Change metering tip |
| | Chemical proportioner faulty | Replace chemical proportioner (PDE61-22-3) |
| | Check valve in filter faulty | Replace filter (PDE100-11P) |
| Tool won't spray - low or uneven spray | Jets clogged | Clean out or replace jets |
| | Inline filter clogged | Clean out or replace filter |
| | Jets worn | Replace jets |
| | Jets not aligned properly | Re-align jets |
| | Tool valve faulty | Repair or replace valve |
| | Quick connects or hoses restricted | Clean out or replace quick connects and/or hoses |
| <p>⚠️WARNING: To reduce the risk of fire electrical shock or injury repairs to wiring should only be performed by experienced service technicians. * If you are not experienced in checking electrical wiring contact your nearest authorized service center to perform tests and repairs to wiring and switches.</p> | | |

| Problem | Cause | Solution |
|--|------------------------------------|--|
| Solution Tank not filling | Water source turned off | Turn on faucet or find other water source |
| | Float not on valve arm | Reconnect float to valve arm - Adjust to proper height/level |
| | Float valve faulty | Repair or replace float valve |
| | Water hose restricted | Un-kink, clean out or replace hose |
| | Water Pressure too high | Use pressure regulator on auto-fill hose |
| | Quick connects faulty | Clean out or replace quick connects (AH101B, AH102B) |
| Solution tank overflowing | Float too heavy/ Filled with water | Replace float |
| | Float & chain tangled | Make sure float chain free & hanging properly |
| | Float too high | Adjust chain to set float at proper level |
| | Water Pressure too high | Use pressure regulator on auto-fill hose |
| | Float valve faulty | Repair or replace float valve |
| Chemical Jug Filling with water - Overflowing | Foot valve in Filter stuck | Clean out foot valve and filter |
| | Foot valve in Filter faulty | Replace foot valve and filter (PDE100-11P) |
| | | |
| <p>⚠WARNING: To reduce the risk of fire electrical shock or injury repairs to wiring should only be performed by experienced service technicians. * If you are not experienced in checking electrical wiring contact your nearest authorized service center to perform tests and repairs to wiring and switches.</p> | | |

- Contact your distributor for additional troubleshooting assistance, to order parts, or for advice and assistance in performing necessary repairs.

MX500

Solution Flow Path

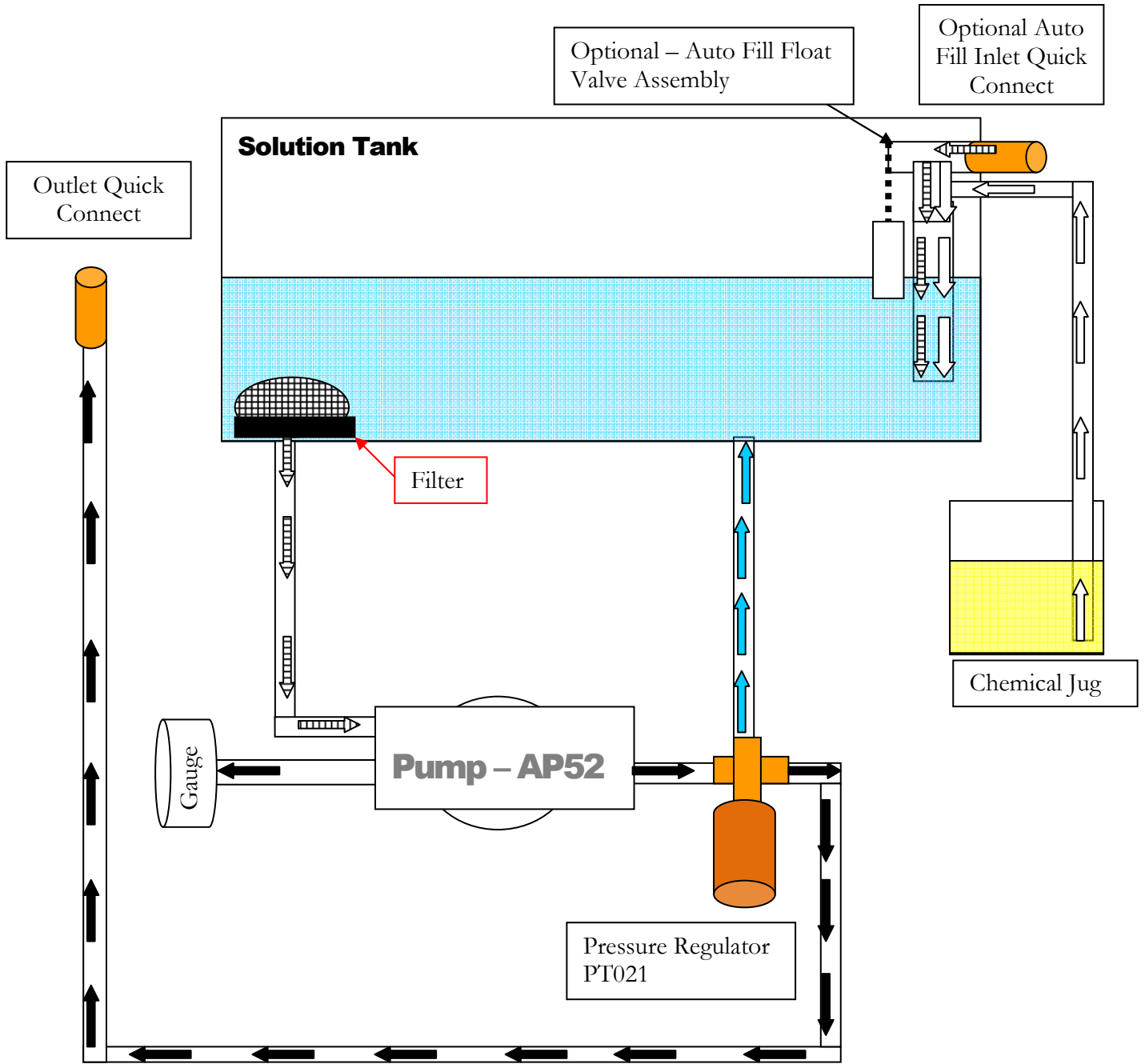

Denotes incoming water flow



Denotes Water flow in high pressure hose



Denotes by-pass water flow from pressure regulator



Denotes Chemical flow



MX500E Wiring Diagram

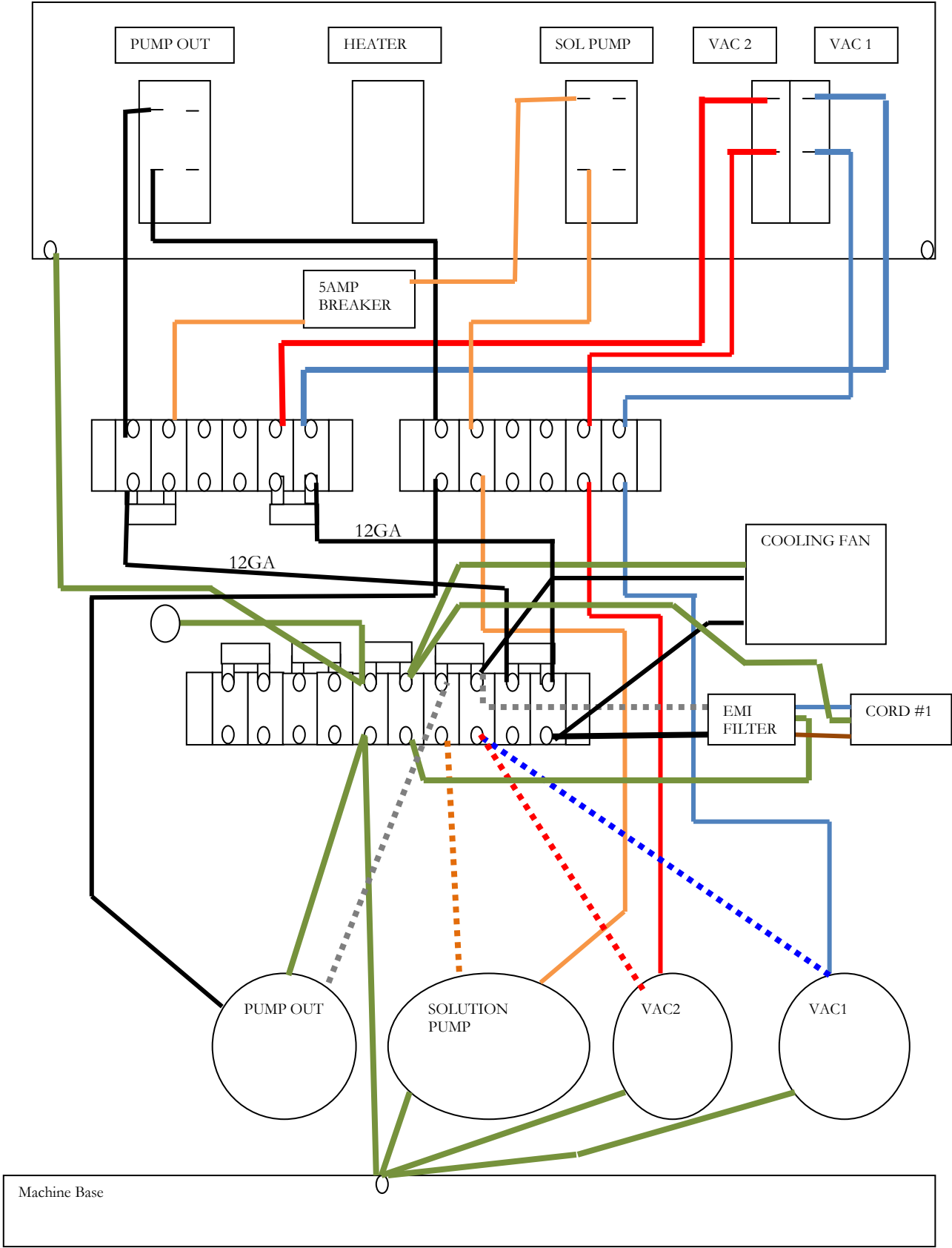

NAUTILUS MX500E SWITCH PANEL:

(Shown with optional Pump-Out switch)

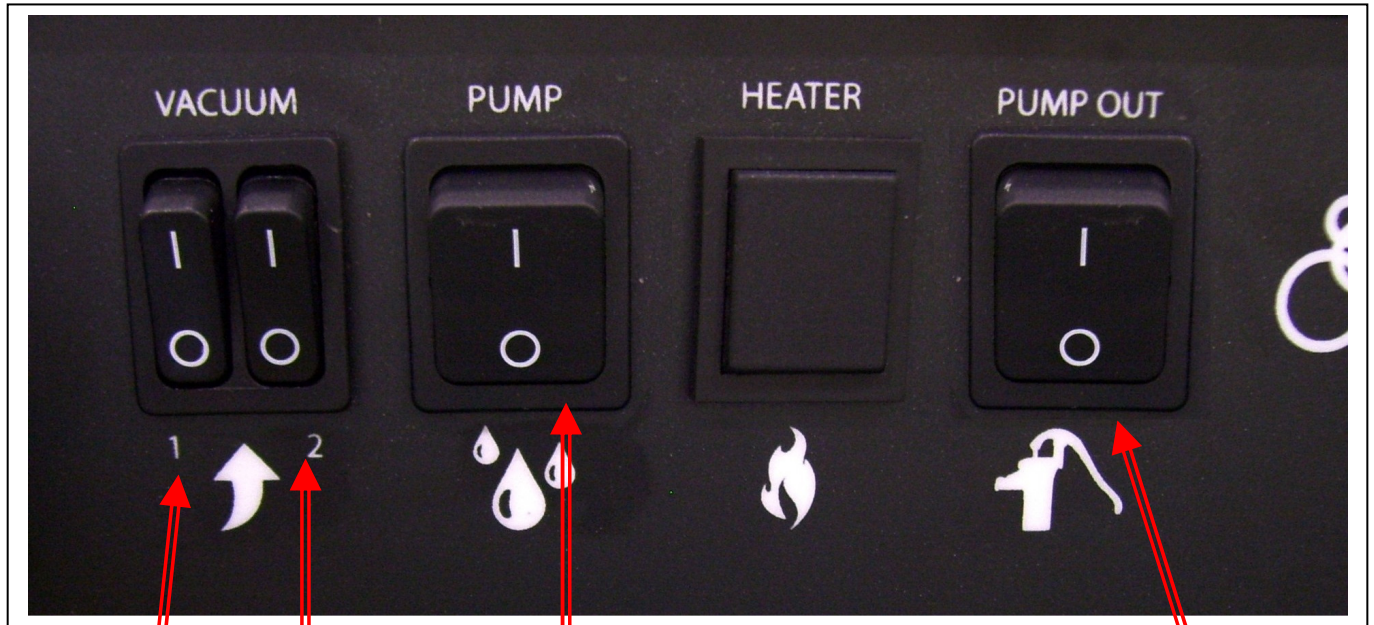

Solution Pump Switch

When the switch is turned to the ON position power is supplied to the solution pump motor. When not using solution (Extracting Only) do not turn this switch ON.

Vacuum #1

When the switch is turned to the ON position power is supplied to the vacuum motor. (2-Stage Vacuum)

Vacuum #2

When the switch is turned to the ON position power is supplied to the vacuum motor. (2-Stage Vacuum)

OPTIONAL - Waste Pump Switch

NOTICE

Do not turn Waste Pump Switch ON unless a hose is connected to the Pump-out Outlet port. For pump protection there is a pressure switch which will turn the waste pump off if the pressure in the discharge line gets too high, as it would if the pump was turned on while the outlet cap was still in place.

Cooling Fan The cooling fan is not controlled by any switch.

As soon as the power cord is plugged in the cooling fan will turn on to exhaust air from the base.

Maintenance

Proper maintenance is required to keep the MX500E operating properly, prevent downtime and to extend the life of your equipment.

⚠️ WARNING

This machine is an electrical appliance. Care must be taken to reduce the risk of electrical shock.

⚠️ WARNING

Disconnect electrical power before performing any service or maintenance inside machine base or before testing or repairing switches or power cords. Failure to do so may result in severe personal injury or death.

| OPERATION | INTERVAL | Page # |
|---|------------------------|--------|
| CLEAN CHEMICAL FEED FILTER & FOOT VALVE | Daily – After Each Job | 27 |
| CLEAN VACUUM SHUTOFF ASSEMBLY SCREEN | Daily – After Each Job | 27 |
| CLEAN HYDRO-FILTER II | Daily – After Each Job | 28 |
| RINSE OUT RECOVERY TANK | Daily | 28 |
| CLEAN WASTE PUMP-OUT PUMP | Daily | 29 |
| FLUSH SOLUTION TANK AND PUMP | Daily | 29 |
| CLEAN PUMP-INLET FILTER | Weekly – As needed | 30 |
| FLUSH CHEMICAL SYSTEM | Monthly | 31 |
| LUBRICATE REGULATOR PISTON SEAL | Monthly | 32 |
| CLEAN DRAIN VALVE | As needed | 33 |
| STORAGE PREP – FREEZE PROTECTION | As needed | 34 |

CLEAN CHEMICAL FEED FILTER & FOOT VALVE: (If so equipped)

Part of the optional Auto Fill & Chemical Feed system, the Filter & Foot Valve is on the end of the chemical feed hose that is placed in the chemical jug as part of the chemical feed system. Regularly examine the filter and clean as needed.

To test the Foot Valve:

- Remove the Filter & Foot Valve from the end of the chemical feed hose and rinse in fresh water.
- Blow through the valve from the filter side of the barb.
 - If the Foot Valve is functioning, air should move freely from the filter side, but will not flow from the barb side of the filter.
 - If valve is not functional, clean or replace as needed.

Heavy chemical build-up can be removed with a mild acid rinse and/or the use of a brush and compressed air.

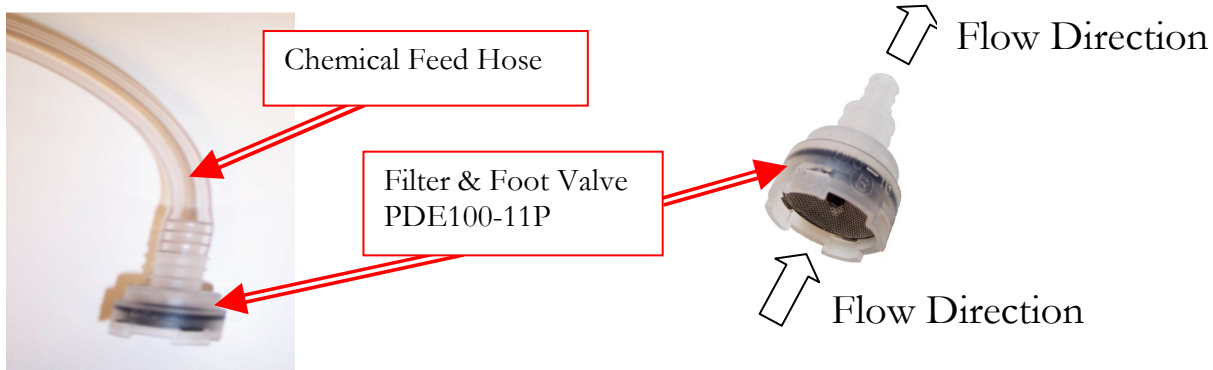

CLEAN VACUUM SHUTOFF ASSEMBLY SCREEN:

Inside the recovery tank, on top of the stand pipe, is the Vacuum Shutoff Assembly. It functions to prevent debris and water from being sucked into the vacuum motors. Operating the MX500E without the Vacuum Shutoff Assembly or with a poorly maintained assembly will greatly decrease the life of the vacuum motors and will void the warranty.

If debris builds up on this filter, it will reduce the vacuum air flow and may cause a significant decrease in the rate of water recovery. If debris prevents the float from moving or seating against the Filter Cap Assembly, it may not stop the airflow when the tank fill with water, and the water will be sucked into the vacuums and blown out the exhaust.

Use defoamer to prevent foam or moisture from entering vacuums (See Page 15).

To clean:

- **Do not pull up on top of cap.** Carefully pull up from the bottom of filter cap assembly to pull the assembly off of the stand pipe. Then pull float off of riser pipe.
- Pull fibers and lint off and rinse filter cap assembly and float with clean water.
- Place the float back on the riser pipe then push the filter cap assembly back onto the stand pipe and replace the recovery tank lid.

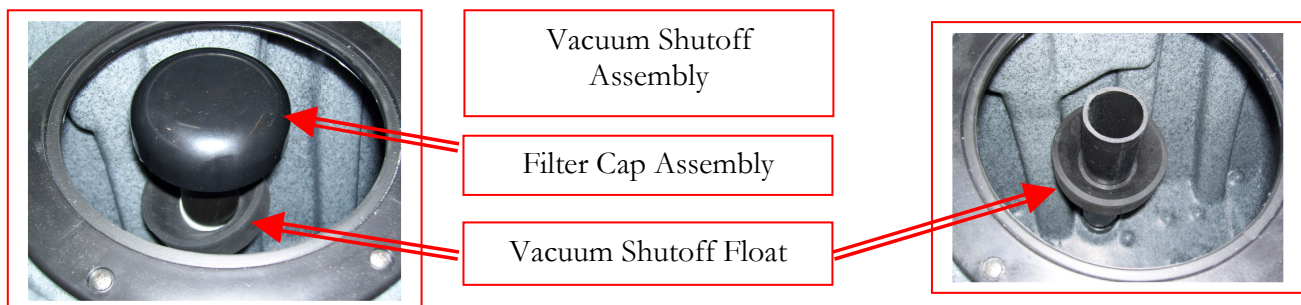

CLEAN THE HYDRO-FILTER II: (If so equipped)

When used with the MX500E, build-up of debris in the filter screen of the optional Hydro-Filter II will reduce the vacuum air flow and may cause a significant decrease in water recovery. A torn filter screen will allow debris past the filter and into the recovery tank. This debris can clog the Waste Pump and the Vacuum Shutoff Assembly. **The Hydro-Filter II must be examined and cleaned regularly to keep the MX500E functioning properly:**

- Grasp and turn the lid counterclockwise to open the Hydro-Filter II lid.
- Remove the filter screen. Examine the screen and clean or replace as needed.
- Rinse the body of the Hydro-Filter II with clean water.
- Examine the o-ring lid seal and replace as needed.
- Re-install the new or cleaned screen.
- Screw the lid back onto the body and turn clockwise to tighten.

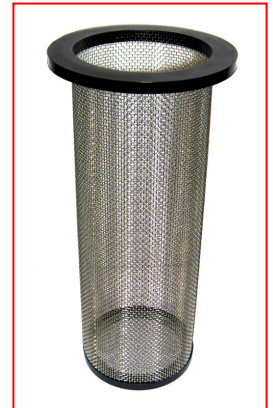

RINSE OUT RECOVERY TANK:

Build-up of fine silt, sand and other debris in the recovery tank can damage the Drain Valve (and Waste Pump if so equipped). Hair and fibers in the recovery tank can clog the vacuum filter (and Pump-out filter if so equipped). Clean out the tank on a regular basis to extend the life of these components and to keep the tank and machine smelling better.

- Remove the recovery tank lid and open the drain valve.
- Place a bucket under the drain valve.
- Use a hose to rinse the dirt and debris out of the recovery tank.
- Close the drain valve and spray the tank with a deodorizer or disinfectant.
- Proceed to Waste Pump Cleaning and replace the recovery tank lid.
- Dispose of the dirty water and debris.



CLEAN WASTE PUMP-OUT PUMP: (If so equipped)

Build-up of fine silt inside the optional Waste Pump can clog the pump even if the pump is not used, so this maintenance procedure should be performed regardless of whether the Waste Pump has been used.

- After cleaning out the recovery tank, remove the cap and connect the Pump-Out hose to the Waste Pump outlet fitting on the back of the machine; run the hose to a drain.
- Remove the waste pump filter screen by turning it counterclockwise. Remove the filter screen. Examine the screen and clean or replace as needed.
- Re-install the filter screen. Thread the filter loosely on to the nipple – Leave slightly loose to keep it easier to remove for future cleaning.
- Use a hose to fill the recovery tank approximately 1/2 full with clean water.
- With the power cord plugged in, turn the Waste Pump switch to the ON position.
- Let the pump run until it pumps the level down to the point below the pump intake filter.
- Unplug the cord and turn the Waste Pump switch OFF.
- Open the drain valve and drain out the remaining water.
- Close the drain valve, replace the recovery tank lid, and dispose of the dirty water and debris.



FLUSH SOLUTION TANK AND PUMP:

- Pour two or three gallons (8-12 liters) of clean water into the solution tank.
- With the power cord plugged in, connect the pump prime hose to the solution outlet female quick connect.
- Direct the end of the pump priming hose into the recovery tank vacuum barb.
- Turn one or both of the vacuums ON and turn the solution pump ON.

Let the pump run until most of the water has been pumped out of the solution tank.

NOTICE Do not let the pump run dry. Turn the pump OFF before the water gets to the bottom of the tank.

- Turn the vacuums OFF and disconnect the prime hose.
- Place a bucket under the drain valve; open the drain valve to drain the water out of the recovery tank.
- Close the drain valve and dispose of the water.



Pour 2 or 3 gallons of clean water into Solution Tank

If there is a heavy chemical build-up in the machine, hoses, or tools, a mild acid can be added to the rinse water in the previous procedure (REFER TO PHOTOS ON FOLLOWING PAGE.)

- After the pump has been primed, turn the solution pump switch OFF and turn the vacuums OFF.
- Remove the pump priming hose and connect the solution hose and tools.
- Turn the solution pump ON and direct the tool spray into a bucket. Let the pump run until most of the water has been pumped out of the solution tank.

NOTICE Do not let the pump run dry. Turn the pump OFF before the water gets to the bottom of the tank.

FLUSH SOLUTION TANK AND PUMP: (continued from previous page)

- Disconnect the solution hose and tool.
- Use the vacuum hose to vacuum the remaining acid solution out of the solution tank.
- Pour two or three gallons of clean water into the solution tank.
- Connect the pump priming hose to the solution outlet female quick connect.
- Direct the end of the prime hose into the recovery tank vacuum barb.
- Turn one or both of the vacuums ON and turn the solution pump ON. Let the pump run until most of the water has been pumped out of the solution tank. **Do not let the pump run dry. Turn the pump OFF before the water gets to the bottom of the tank.**
- Turn the vacuums OFF and disconnect the prime hose.
- Place a bucket under the drain valve and open the drain valve to drain the water out of the recovery tank.
- Close the drain valve and dispose of the water.



Vacuum acid solution out of Solution Tank

CLEAN PUMP INLET FILTER

A restricted Pump Inlet Filter can prevent the solution pump from providing adequate pressure for cleaning. A restriction or air leak on the pump inlet hose can also damage the solution pump check valves and plunger seals.

- To examine the filter, open the solution tank lid on the front of the machine. The filter is in the bottom of the solution tank.
- Grasp the filter cap and unscrew the filter from the brass nipple by turning counter-clockwise. Clean or replace the filter as needed (PP14-806504).



Inside View: MX500E Solution Tank

⚠ WARNING Before proceeding with this procedure, drain the solution tank & recovery tank. Make sure both power cords are disconnected.

- To examine the pump inlet hose, release the latches on the front/bottom of the machine and tilt the tanks off of the base assembly.
- Examine the hose for kinks, clogs or holes and repair or replace the hose as needed. (Replacement Hose: NM5086 – sold per foot)
- Tilt the tanks back onto the base and secure the latches.

SOLUTION FILTER
PP14-806504



FLUSH CHEMICAL SYSTEM: (If so equipped)

Chemical build-up in the optional Auto Fill chemical system can prevent the system from drawing chemical.

- Rinse the chemical system with fresh water (For heavy chemical build-up, a mild acid can be added to the rinse water.)
- Remove the chemical feed hose from the solution tank and place the end of the hose in a bucket of fresh water or mild acid solution.
- Connect the Auto-Fill Water Supply Hose to the water inlet (male quick connect) on the front of the machine.
- Connect the other end of the hose to a water faucet and turn on the water. Let the water flow into the tank until you are sure the rinse solution has been drawn through the proportioner and mixed with the incoming water. The metering tip can be removed from the proportioner to speed up the process.
- Once the rinse solution has been drawn through the proportioner, turn off the water faucet and disconnect the Auto-Fill Water Supply Hose.
- Plug in Cords, connect the vacuum hose to the vacuum barb, turn on one or both vacuums, and use the vacuum hose to remove the water from the solution tank.
- When the solution tank has been emptied, turn off the vacuums and unplug the power cord.
- Place a bucket under the drain valve and open the drain valve to drain the water from the recovery tank.
- Close the drain valve and dispose of the water.

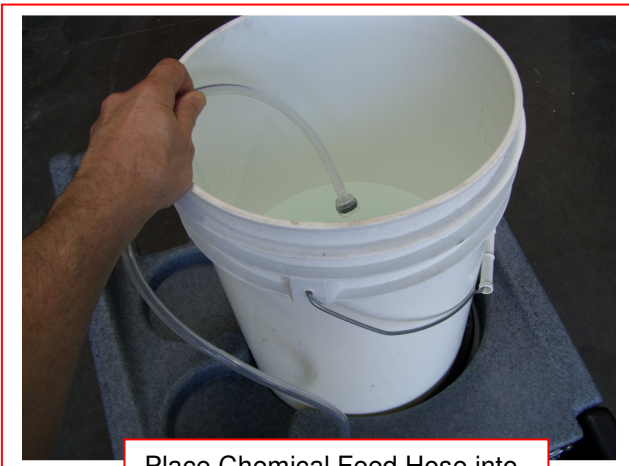

Place Chemical Feed Hose into Rinse Solution

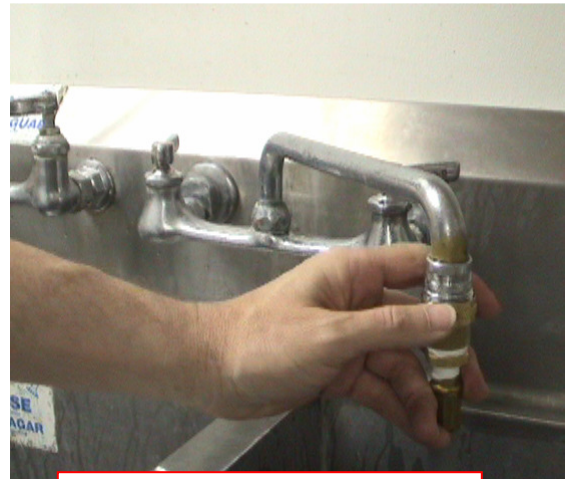

Connect Auto-Fill Water Supply Hose to machine and faucet



Vacuum water out of Solution Tank



Drain water from Recovery Tank

LUBRICATE REGULATOR PISTON SEAL

To maintain consistent adequate pressure delivery to the cleaning tool, the piston seal of the MX500E pressure regulator must be lubricated regularly.

1. Release pressure from system before proceeding.
2. Remove Brass Knob from the regulator body.
3. Remove the Spring and Spring Plate from the Regulator Body.
4. Use needle nose pliers to pull the Piston from the Regulator Body.
5. Examine Piston and Seal. Replace as needed.

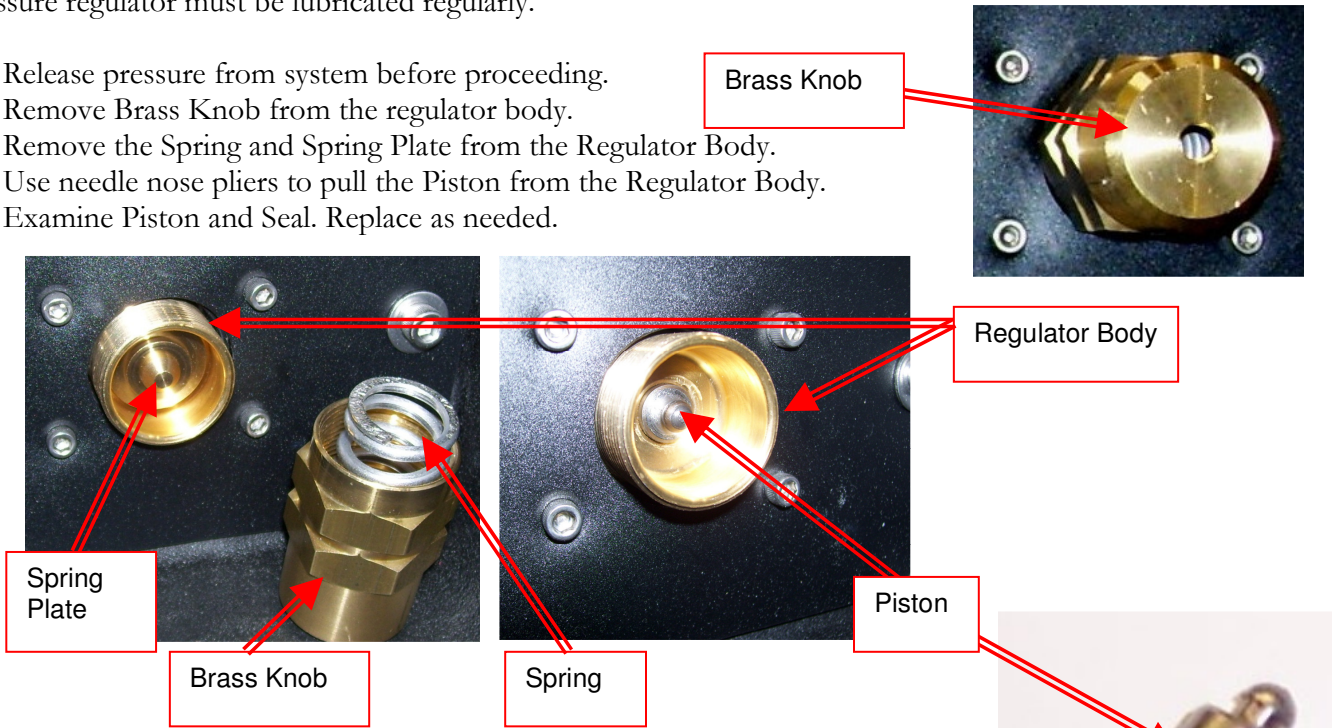

6. Use a synthetic grease with Teflon such as Ultra-Slick or Super-Lube to lubricate the seal on the regulator piston.
7. Place the piston back into the opening on the regulator body.
8. Place the Spring Plate on top of the piston. (Concave side toward piston.)
9. Place the spring back into the handle and thread the handle back onto the regulator body.



Lubricate Piston Seal with synthetic grease



Place concave side of Spring Plate on top of piston.



CLEAN RECOVERY TANK DRAIN

Debris and sand accumulation in the drain valve can damage the valve or prevent it from closing completely. This will result in dirty water leaking from the valve. Use of the Hydro-Filter and regular cleaning of the recovery tank will help prevent this, but occasionally the drain valve will require cleaning or replacement.

⚠ WARNING

Unplug the power cord and drain the recovery tank before attempting to service the drain valve.

- Unscrew the nuts and remove the four bolts holding the valve assembly to the flange attached to the recovery tank. Unless the flange is damaged, it does not have to be removed from the tank, even when replacing the drain valve.
- Separate the valve body, outlet adapter and gaskets from the flange.



Remove four bolts holding valve assembly to flange fitting

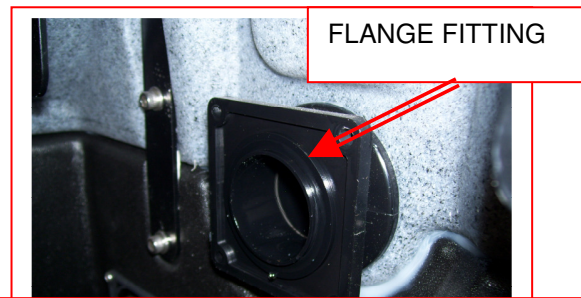

FLANGE FITTING

Unless damaged or leaking between tank and flange, the flange fitting does not have to be removed



DRAIN VALVE – PEA11

VALVE BODY

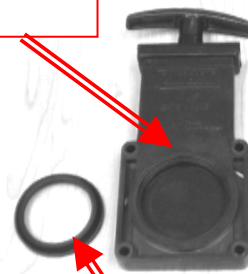

GASKET – NM3019

OUTLET ADAPTER

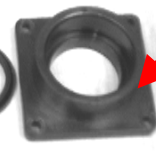

- Examine the valve body for wear. Check the valve slide for deep scratches. Deep scratches will allow water to flow past gaskets and leak from valve. Replace valve if needed.
- Examine the gaskets and replace if cut, torn or deformed.
- Raised, rounded side of gasket goes toward valve slide. Larger flat sides seat on ring on flange and outlet adapter. Sand and debris will collect in the bottom of the valve body and prevent the slide from going down and seating properly.
- Clean debris out as needed so slide can move to bottom.
- Rinse valve body and reassemble valve body, gaskets and outlet adapter, and place assembly back onto flange fitting.
- Replace four bolts and tighten evenly to secure assembly to flange. Do not over-tighten bolts.



Clean debris from slot in bottom of valve body. Valve slide must be able to slide to bottom.

Storage Prep and Freeze Protection Procedures:

Your Nautilus MX500E must be protected from freezing. Freezing can cause serious damage to the pump, pump-out, auto-fill float valve, and any other component containing water. If the MX500E is transported or stored in freezing temperatures, the following procedures should be performed.

ALSO, if the MX500E is stored for an extended period of time, the following procedure should be performed to prevent the pump seals from drying out.

1. In a separate container mix 1/2 gallon (2 liters) of water with 1/2 gallon(2 liters) of automotive radiator Ethylene Glycol anti-freeze. (Propylene glycol can be used as a non-toxic alternative anti-freeze.). Mix well and pour into the solution tank.
2. Connect the solution hose to the solution outlet (female quick connect).
3. **If not equipped with the optional Auto Fill System**, snap an open quick connect onto the other end of the hose and place the hose end back into the solution tank. Turn the pressure regulator knob counter-clockwise to lower the pressure to 100psi or lower.

If equipped with the Auto Fill system, connect the opposite end of the HP solution hose to the Auto-Fill inlet (male quick connect.) Leave the chemical feed hose in the solution tank and ensure the check valve filter is submerged in the anti-freeze solution. To speed the process the metering tip can be removed. Turn the pressure regulator knob counter-clockwise to lower the pressure to 100psi or lower

NOTICE

Applying high pressure (over 100psi) to the Auto-Fill system will cause damage to the Float valve and chemical proportioning mechanism.

4. Turn the solution pump switch to the ON position and perform the pump priming procedure. Hold the priming valve open for a few extra seconds to be sure the anti-freeze has passed through the priming valve. When the pump is primed, allow the anti-freeze to circulate for 5-10 minutes. Mix and add more anti-freeze solution as needed. For machines with the optional Auto Fill System, make sure end of chemical feed hose stays submerged in the anti-freeze solution. This will assure that the anti-freeze will be drawn into the proportioning valve.
5. Connect any cleaning tools and solution hoses that will be stored with the MX500E. Direct tool spray back into the solution tank or into a bucket. Repeat for all tools to be protected.
6. Turn the solution pump switch to the OFF position.
7. Use the vacuum hose to vacuum the remaining anti-freeze solution out of the solution tank and bucket.
8. If so equipped, remove the cap from the waste-pump out outlet fitting on the back of the machine. Connect a hose to a drain or hold a bucket up to the fitting to catch the pump-out flow. Remove the lid from the recovery tank. Turn the Waste Pump switch to the ON position to engage the pump-out. Turn off the Waste Pump Switch as soon as you see anti-freeze flowing from the outlet fitting or hose.
9. Drain the remaining anti-freeze solution from the recovery tank and the machine is ready for storage.

RETURNING THE MX500E TO SERVICE AFTER STORAGE OR FREEZE PROTECTION:

To return the MX500E to service, the anti-freeze must be flushed from the machine. Flush the anti-freeze out of the machine by repeating the procedures above using fresh water in place of anti-freeze.

Parts

Replacement parts available for repair of your MX500E.

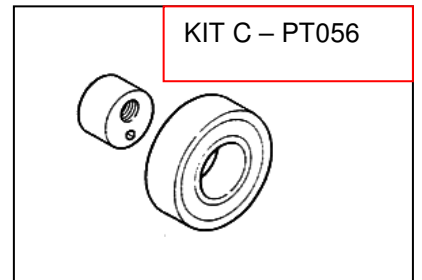
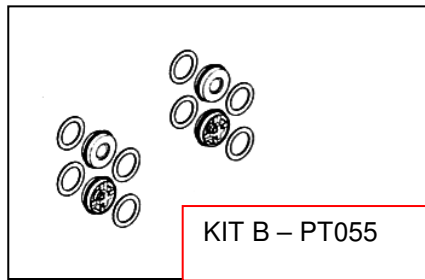
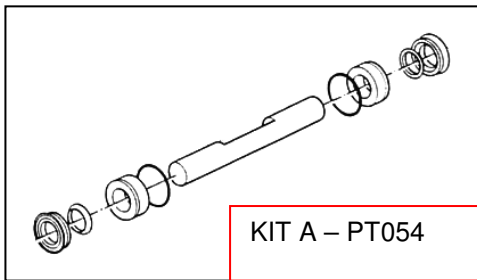
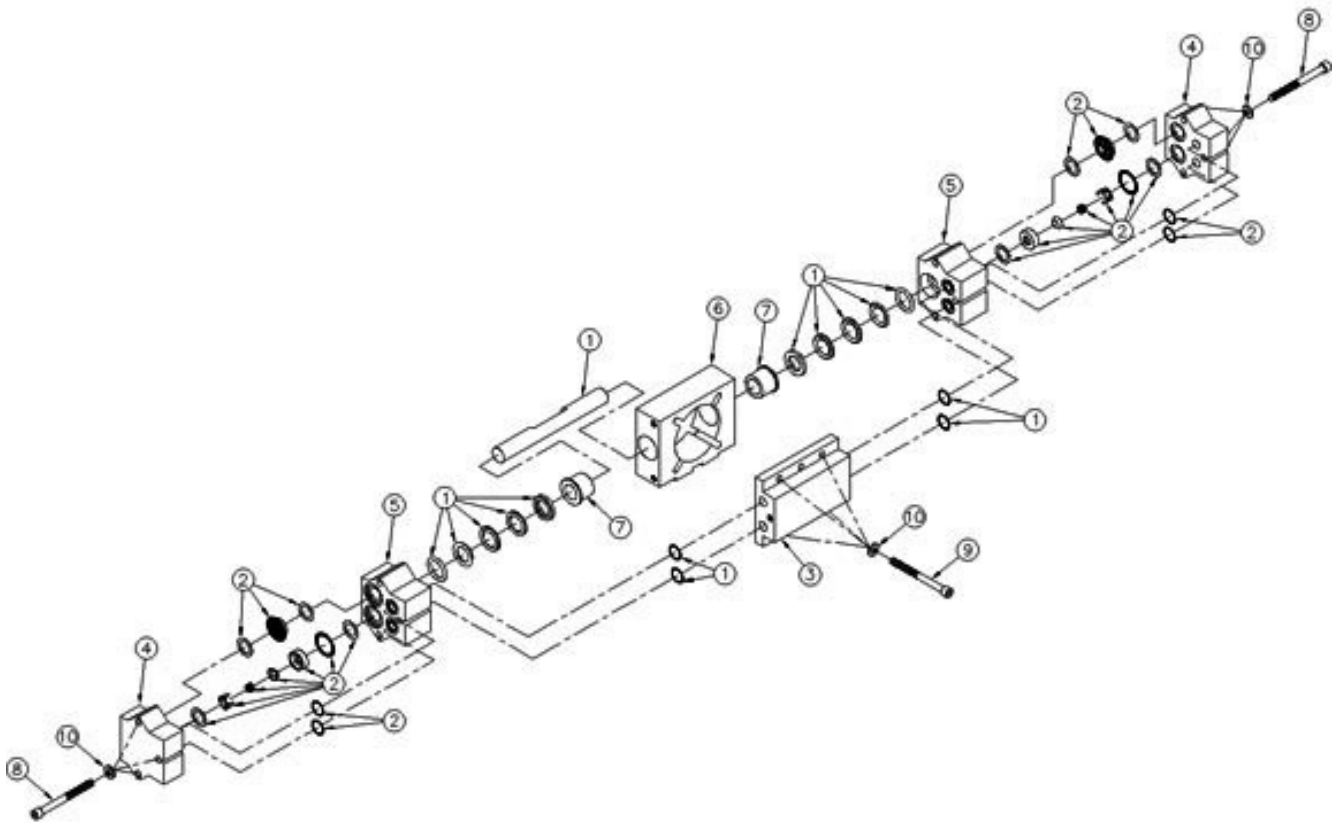

PUMPTEC #207 PUMP – AP52

| ITEM | DESCRIPTION | QTY | PART NUMBER |
|------|--------------------------------|-----|-------------|
| 1 | KIT A PLUNGER & SEALS | 1 | PT054 |
| 2 | KIT B VALVES & O-RINGS | 1 | PT055 |
| NS | KIT C CAM & BEARING | 1 | PT056 |
| 3 | MANIFOLD | 1 | |
| 4 | PUMP HEAD | 2 | |
| 5 | STUFFING BOX | 2 | |
| 6 | CRANKCASE | 1 | |
| 7 | PLUNGER GUIDE | 2 | |
| 8 | HEAD BOLT | 6 | |
| 9 | MOUNT BOLT | 4 | |
| 10 | WASHER FLAT M6 STAINLESS STEEL | 10 | |
| NS | PUMP COMPLETE - WITH MOTOR | 1 | AP52 |
| NS | PUMP COMPLETE - WITHOUT MOTOR | 1 | PT065 |
| NS | MOTOR | 1 | PT066 |

PRESSURE REGULATOR – PT021

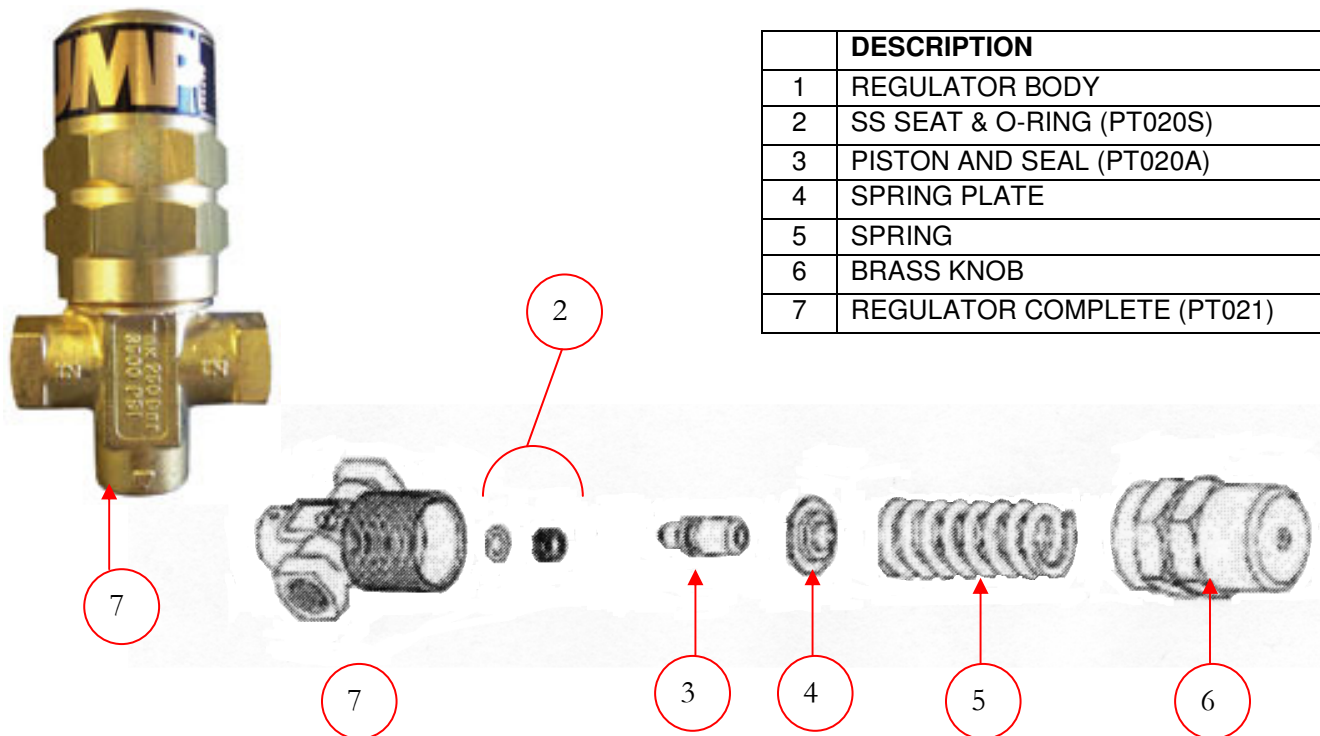

| | DESCRIPTION |
|---|----------------------------|
| 1 | REGULATOR BODY |
| 2 | SS SEAT & O-RING (PT020S) |
| 3 | PISTON AND SEAL (PT020A) |
| 4 | SPRING PLATE |
| 5 | SPRING |
| 6 | BRASS KNOB |
| 7 | REGULATOR COMPLETE (PT021) |

OPTIONAL AUTO-FILL ASSEMBLY – M013

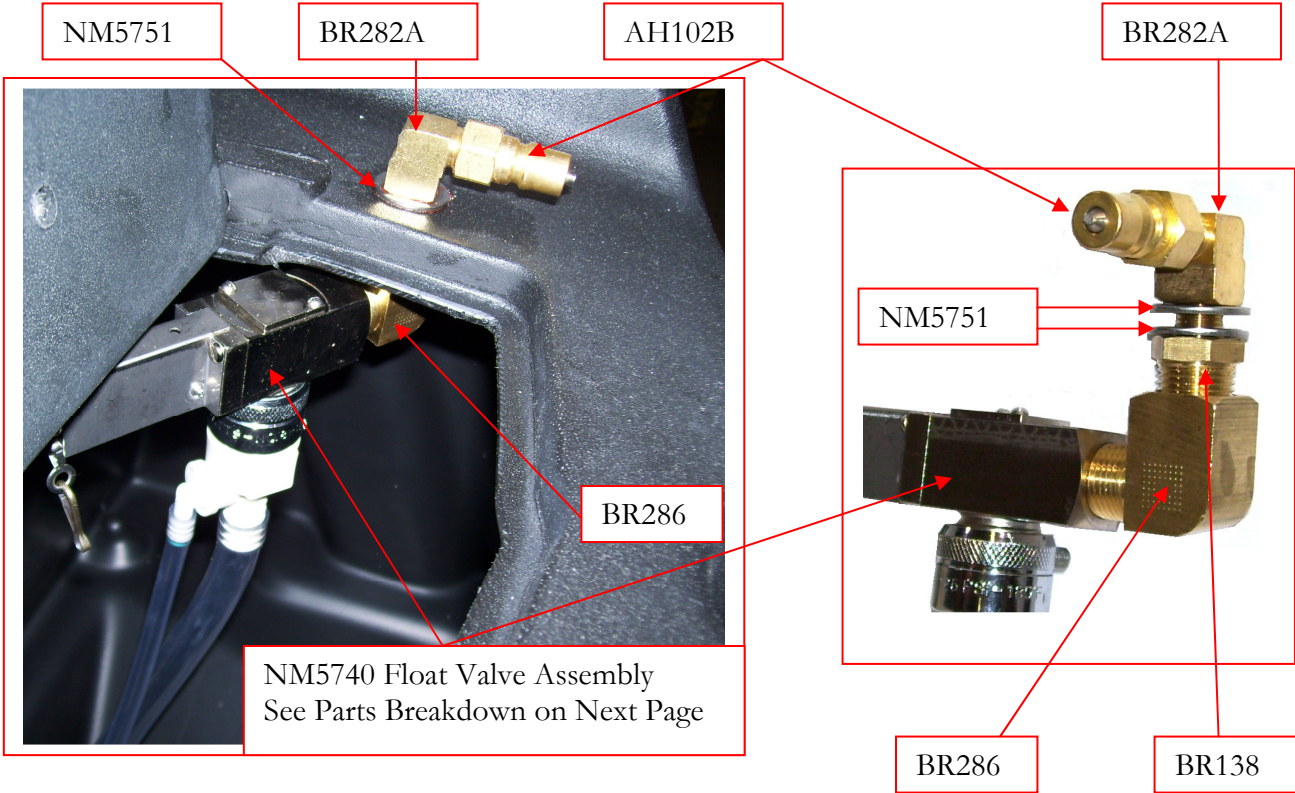

OPTIONAL AUTO-FILL FLOAT VALVE ASSEMBLY NM5740

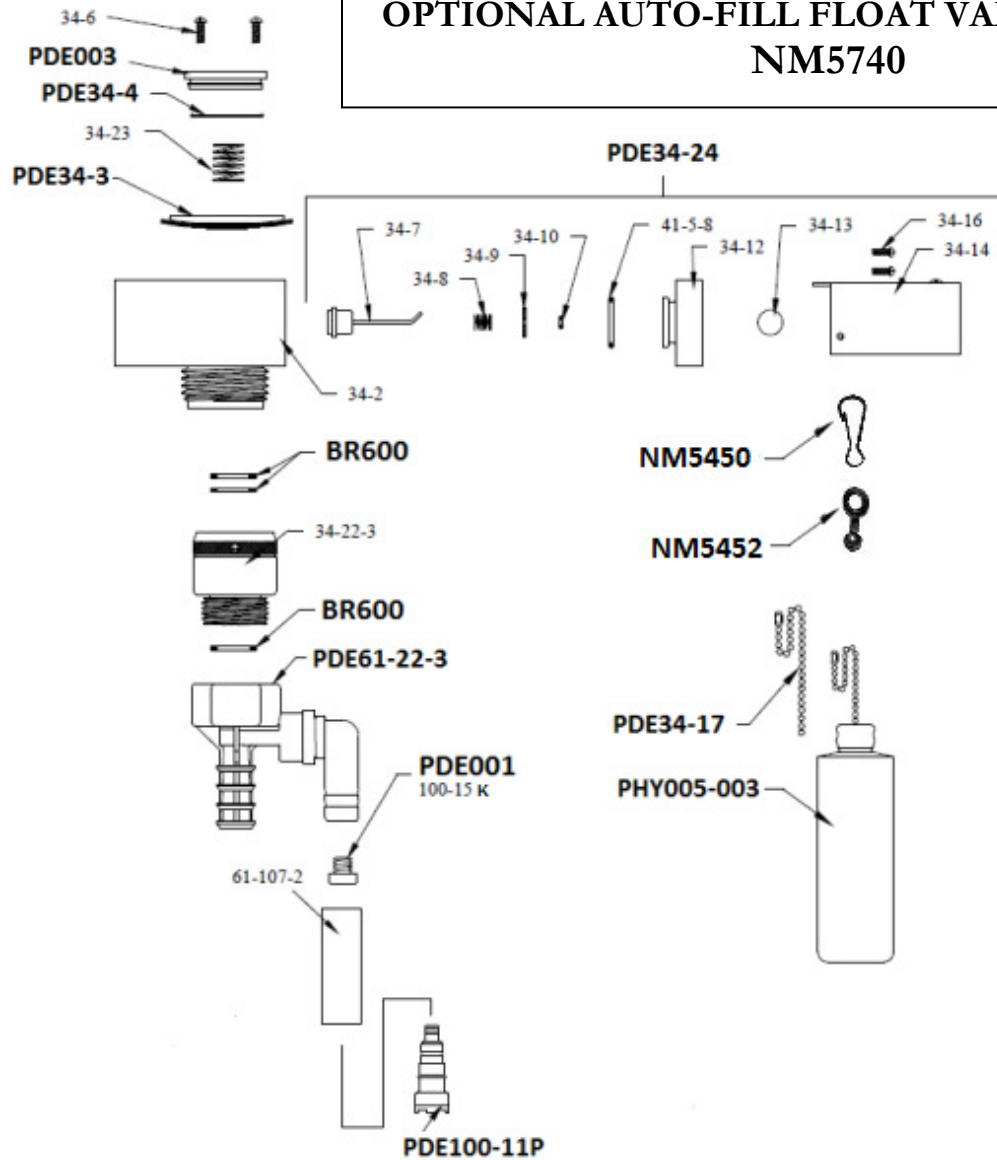

| PART NO. | DESCRIPTION | PART NO. | DESCRIPTION |
|----------|------------------------------------|------------|--------------------------------------|
| 16-3 | 3' DISCHARGE TUBING | PHY005-003 | FLOAT ASSEMBLY |
| 34-1 | INLET HOSE ADAPTER | PDE34-17 | CHAIN WITH CONNECTOR |
| 34-2 | BODY ASSEMBLY | PDE61-22-3 | PROPORTIONER ASSY |
| PDE34-3 | DIAPHRAGM ASSEMBLY | 61-107-2 | CERAMIC WEIGHT |
| PDE34-4 | VALVE COVER O-RING | NM5450 | SNAP CLIP |
| PDE003 | VALVE COVER | NM5452 | CONNECTOR |
| 34-6 | VALVE COVER SCREWS (2) | BR600 | RUBBER WASHER |
| 34-7 | PILOT VALVE DISC AND STEM ASSEMBLY | PDE001 | METERING TIP KIT 14 TIPS |
| 34-8 | PILOT VALVE SPRING | 100-15 | METERING TIP SPECIFY SIZE |
| 34-9 | PILOT VALVE PLATE | 100-12 | 8' PLASTIC SUPPLY TUBING 1/4" ID |
| 34-10 | PILOT VALVE STEM O-RING | PDE100-11P | FOOT VALVE |
| 34-12 | PILOT VALVE COVER | | |
| 34-13 | STEM NUT WITH SET SCREW | AH102B | QUICK CONNECT 1/4" MALE |
| 34-14 | LEVER ASSEMBLY | BR282A | ELBOW 90DEG 1/4" STREET LONG PROFILE |
| 34-16 | LEVER ASSEMBLY SCREWS (2) | NM5751 | WASHER 1/4" FLAT SS (2) |
| 34-22-3 | BACKFLOW PREVENTER | BR138 | NIPPLE 1/2" X 1/4" HEX |
| 34-23 | CLOSING SPRING | BR286 | ELBOW 90 DEG 1/2" STREET |
| PDE34-24 | PILOT VALVE ASSEMBLY | | |
| 41-5-8 | PILOT VALVE COVER O-RING | M013 | NAUTILUS AUTO FILL KIT - COMPLETE |

Optional Pump-Out Pump

AP37F

PARTS ASSEMBLY

AP37F PARTS LIST

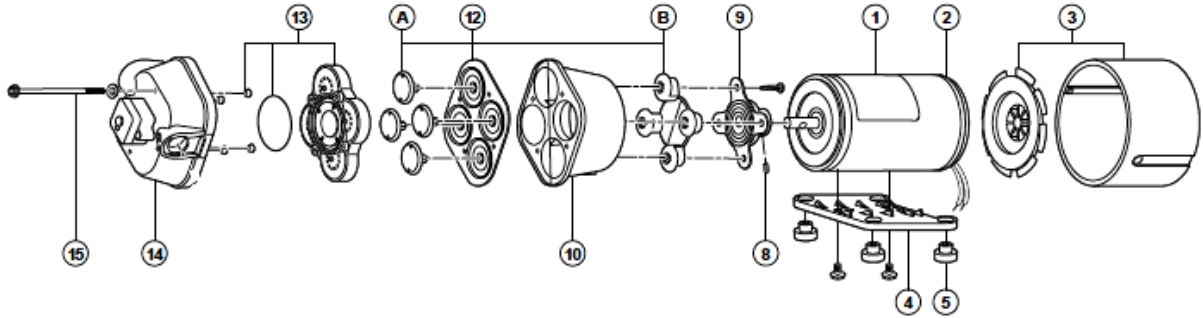

| KEY PART NO. | DESCRIPTION | QTY | KEY PART NO. | DESCRIPTION | QTY |
|--------------|---|----------|---|---|-----|
| 1 | R2039-139 230V AC Mtr | 1 | 13 | 20407-020 Viton ® Check Valve Kit w/"O" Ring & Ferrules | 1 |
| 2 | N/A Brush Endbell/Rect. Assy. (AC) w/BRG | 1 | 14 | N/A Upper Housing Assy Kit V/G SW45 | 1 |
| 3 | 20132-005 Fan/Shroud Kit | 1 | 15 | 20405-000 Pump Screw Kit w/Washer & Ferrules | 1 |
| 4 | 11028-101 Plastic Baseplate Assy. with Grommet & Screws | 1 | 20381-010 3/4" Port Kit EPOM 90 DEG ELBOW | | 2 |
| 5 | 20132-000 Grommet Kit | Set of 4 | | | |
| 8 | 20552-000 Cam/Bearing Set Screw | 1 | | | |
| 9 | Cam/Bearing Kit w/Set Screw | | | | |
| | 20400-003 | 1 | | | |
| 10 | 20401-000 Bearing Cover P.P. | 1 | | | |
| 12 | 20403-040 Diaphragm Kit w/Pistons & Screws Santoprene ® | 1 | | | |

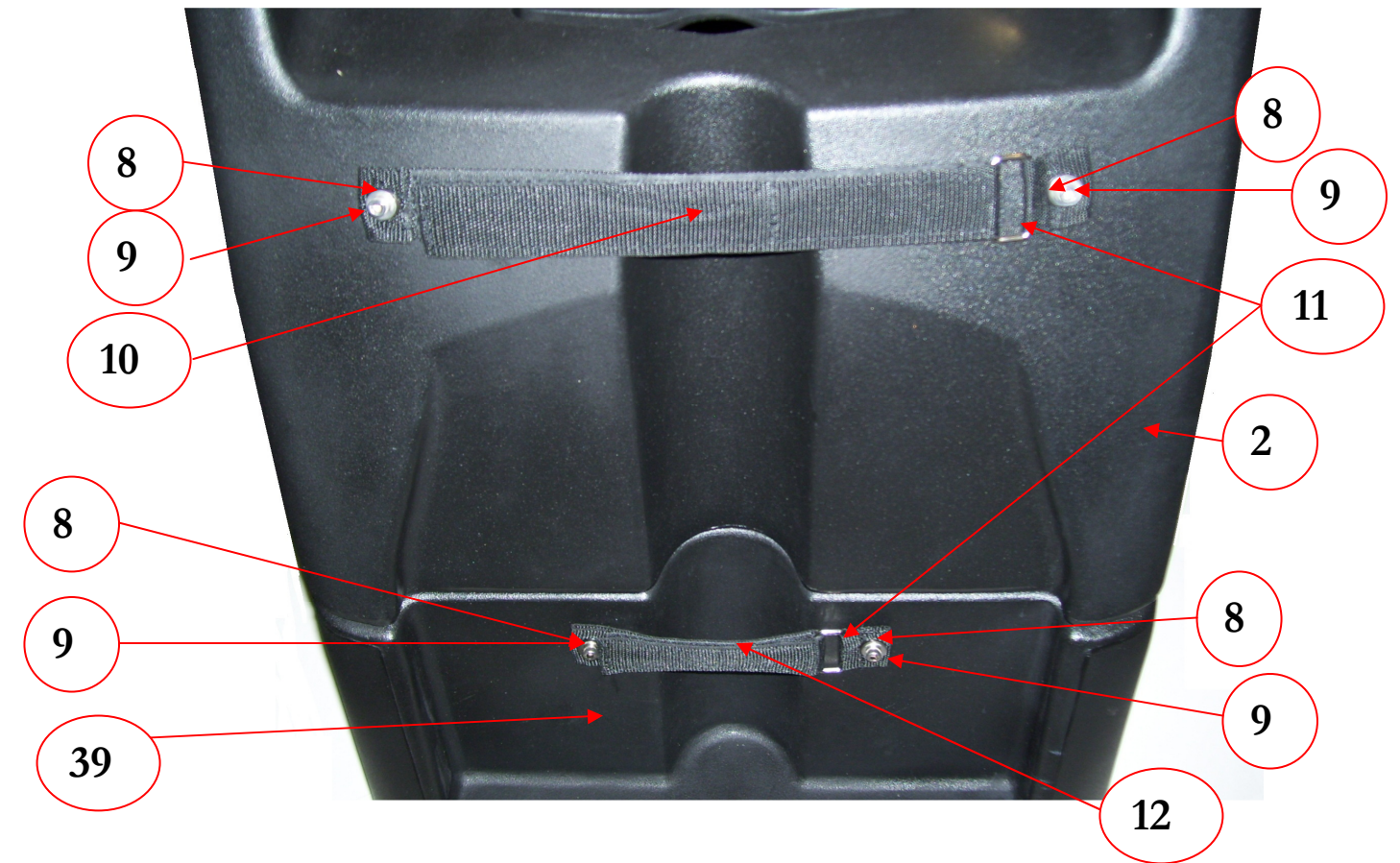
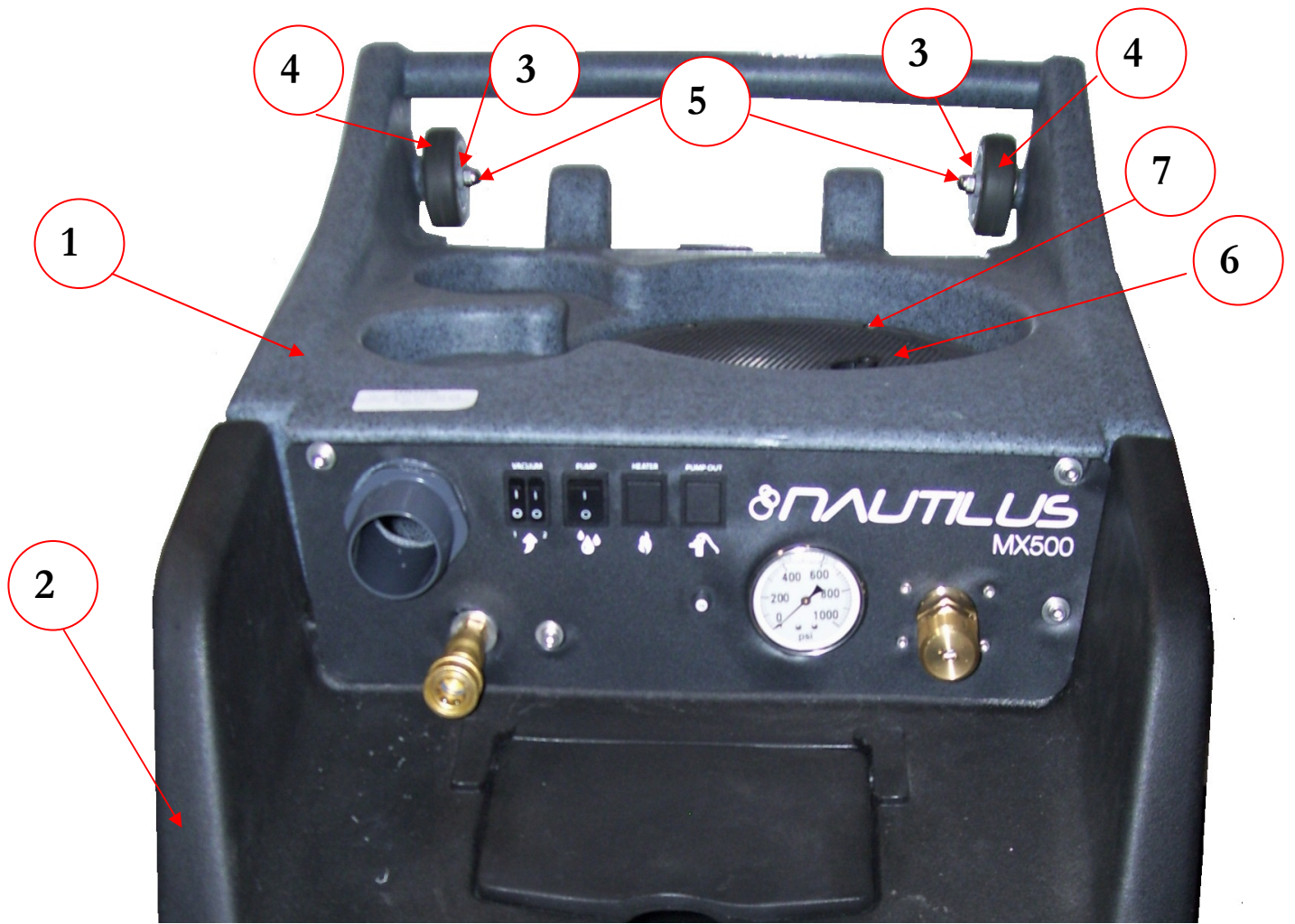

CONTROL PANEL

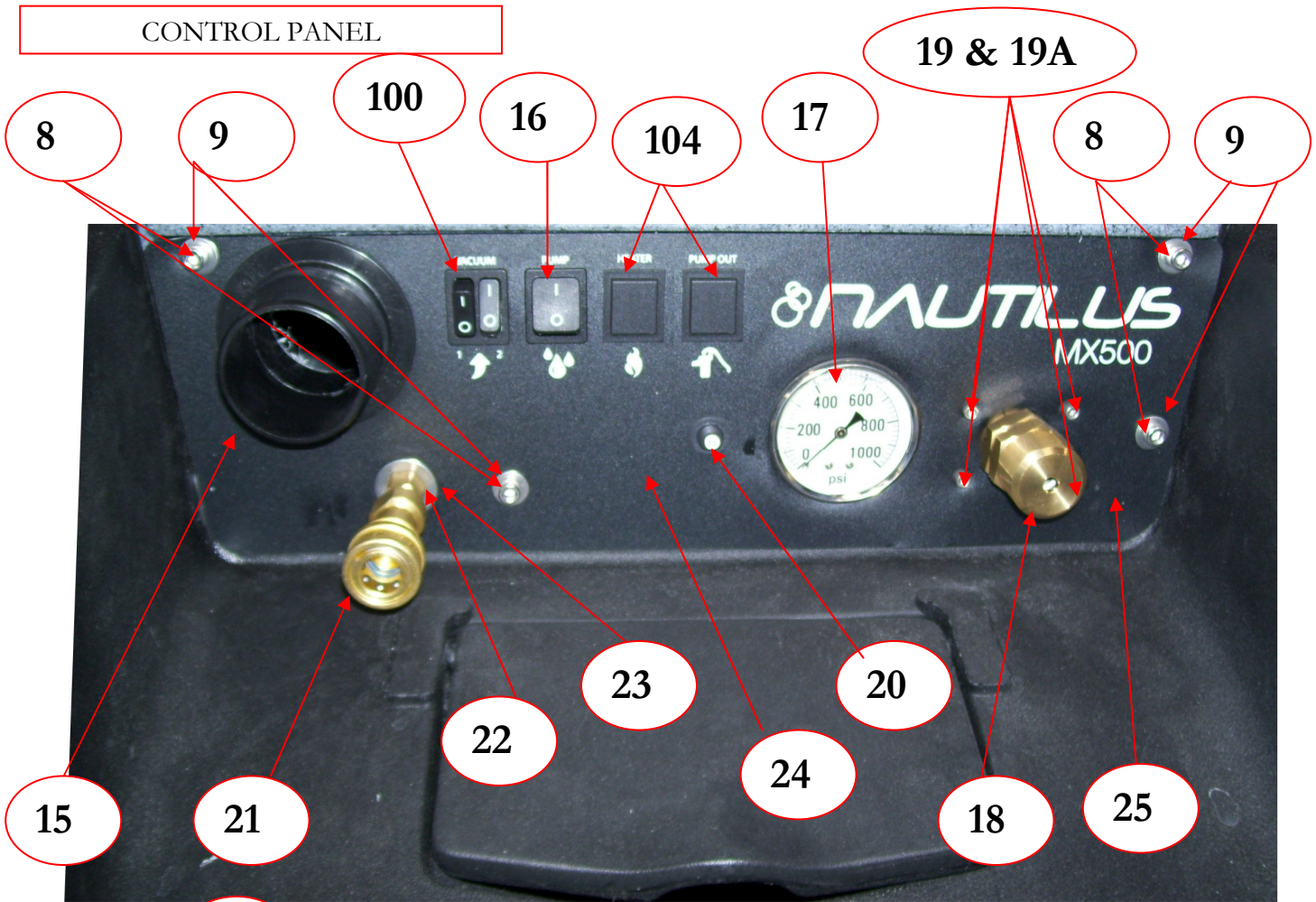

REAR VIEW - BASE & BASE SKIRT

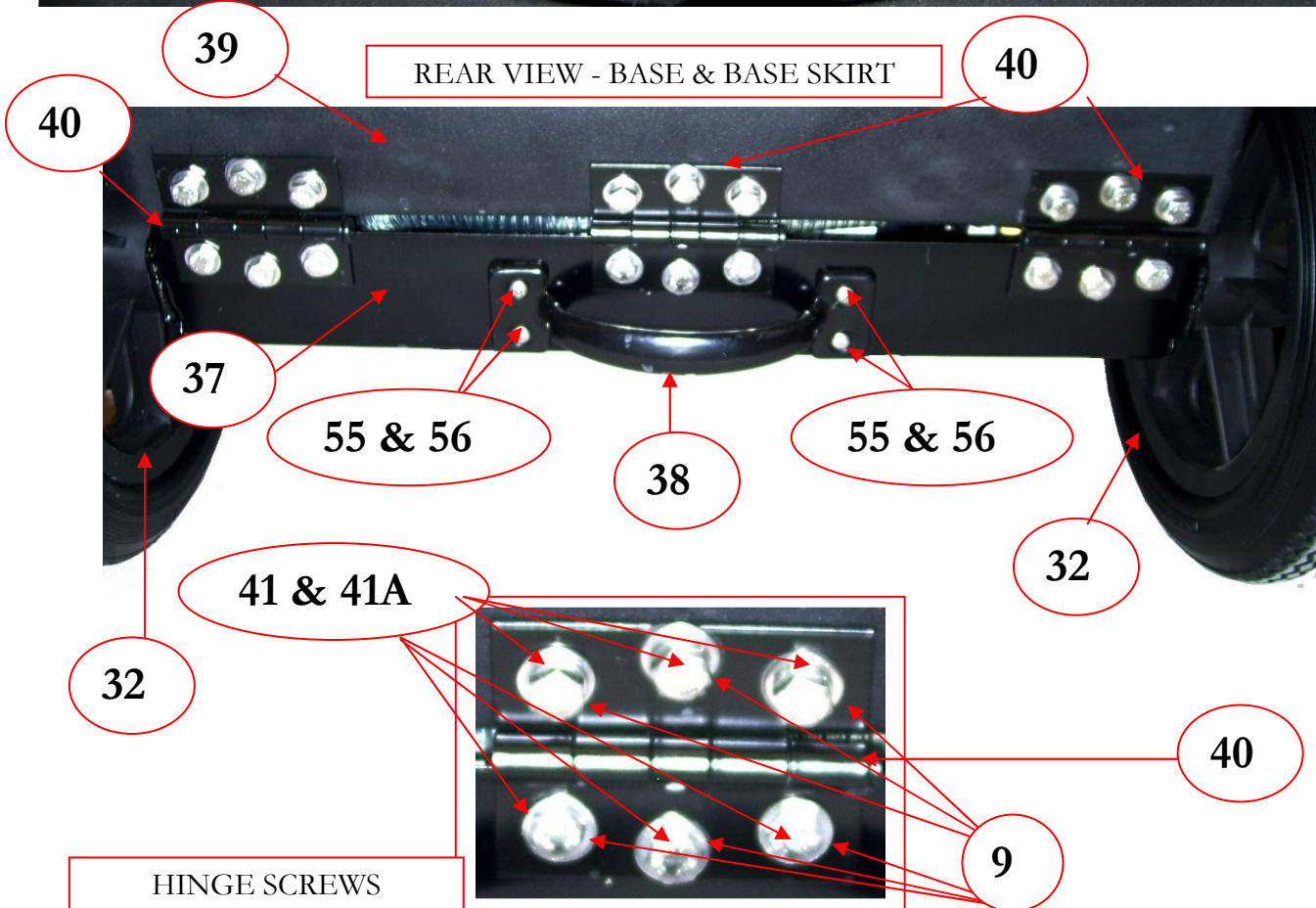

HINGE SCREWS

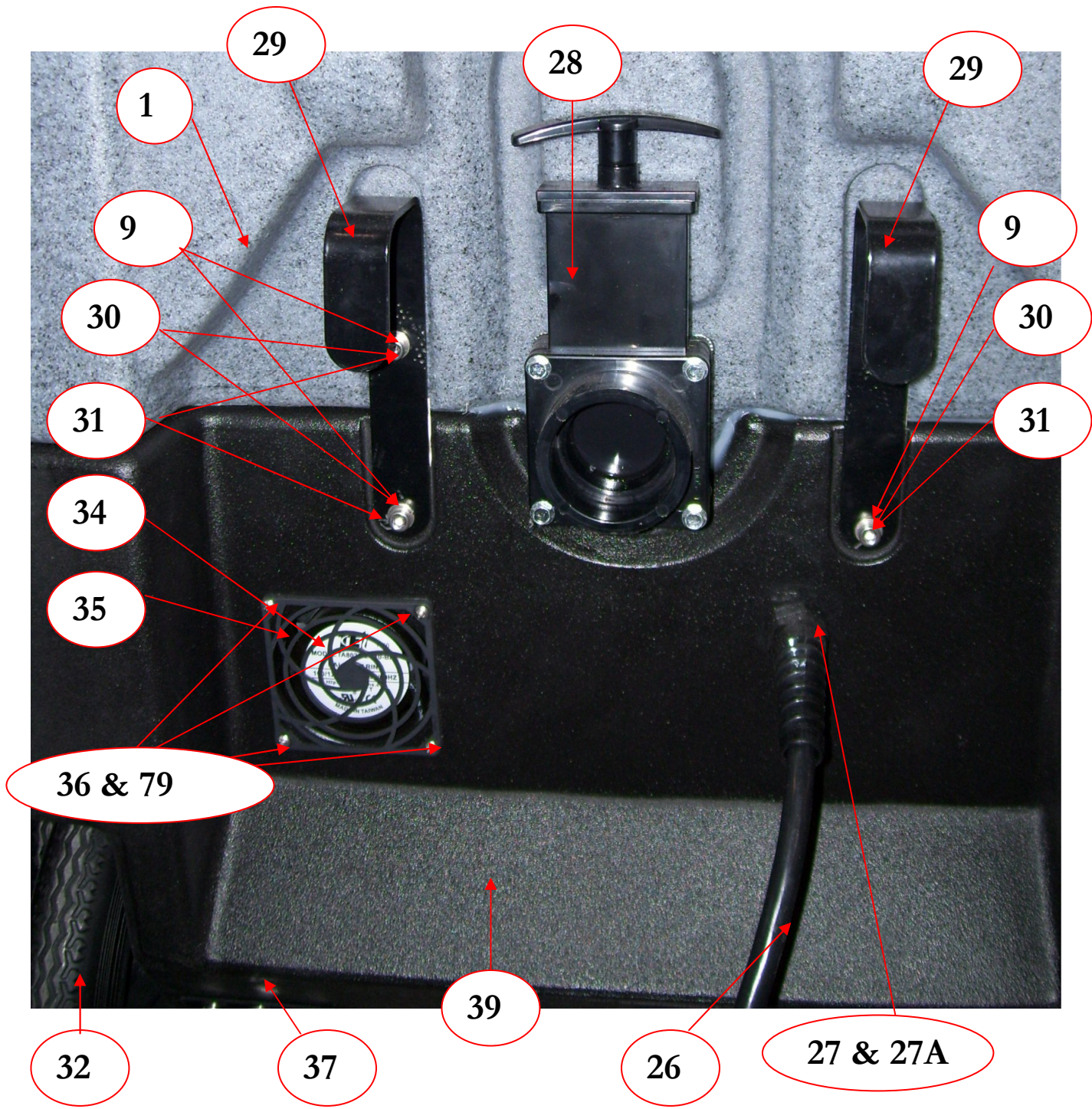

REAR VIEW – BASE, BASE SKIRT & RECOVERY TANK

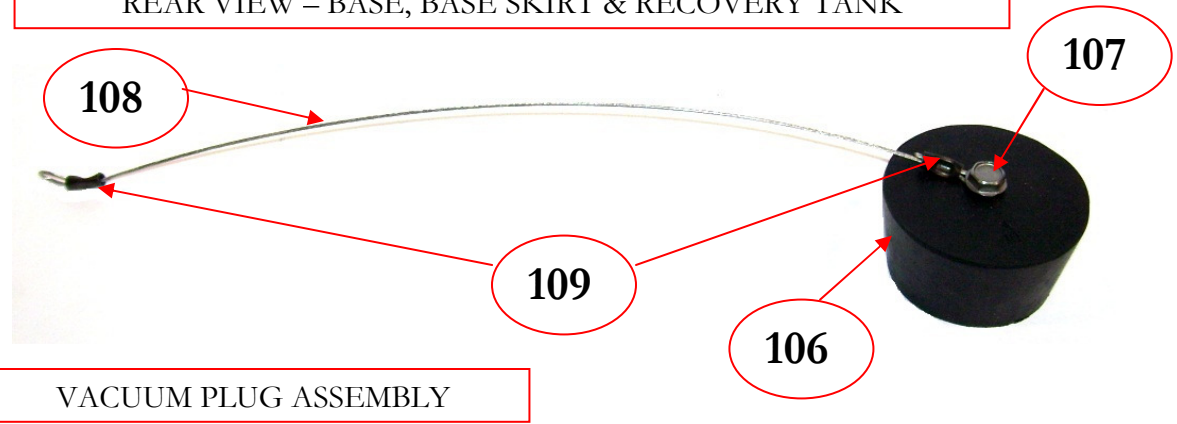

VACUUM PLUG ASSEMBLY

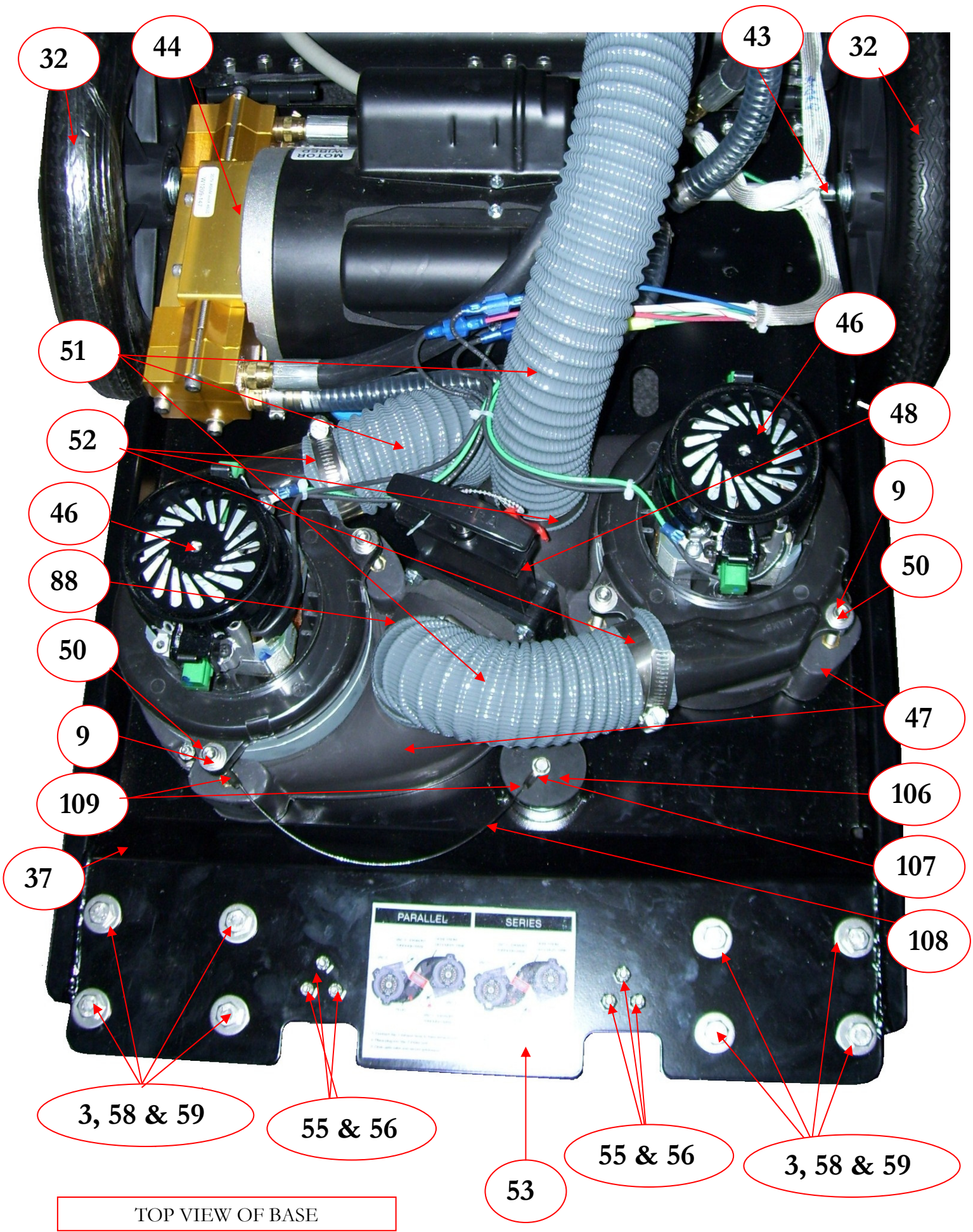

VACUUM MOUNTS & CONNECTIONS

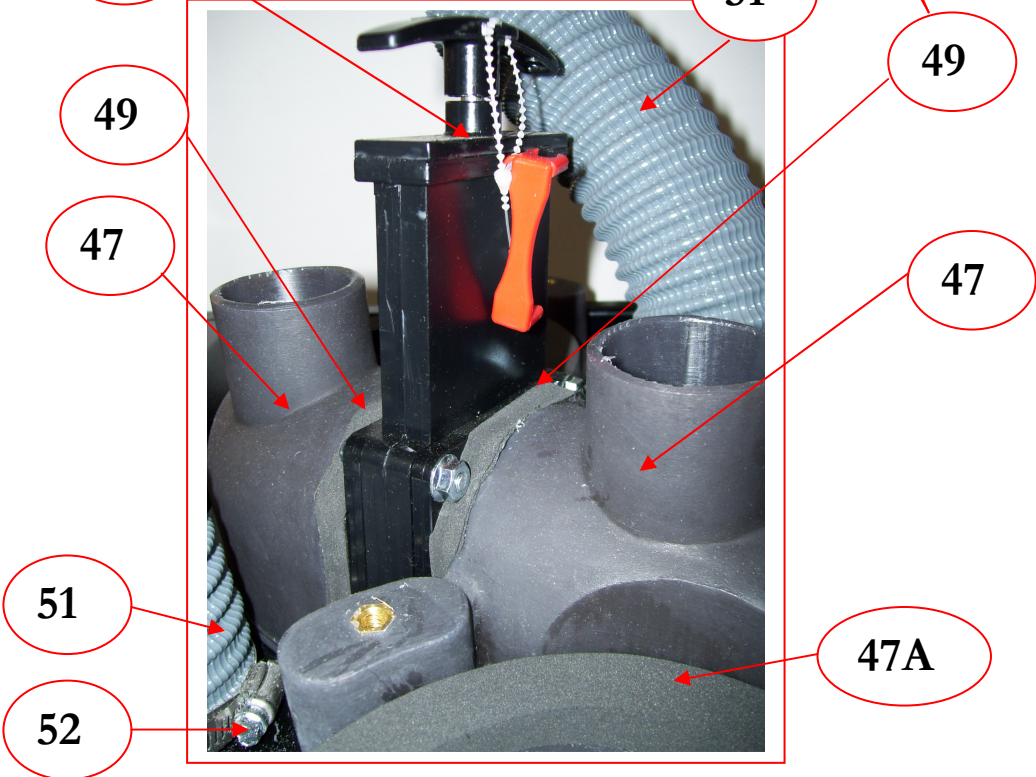
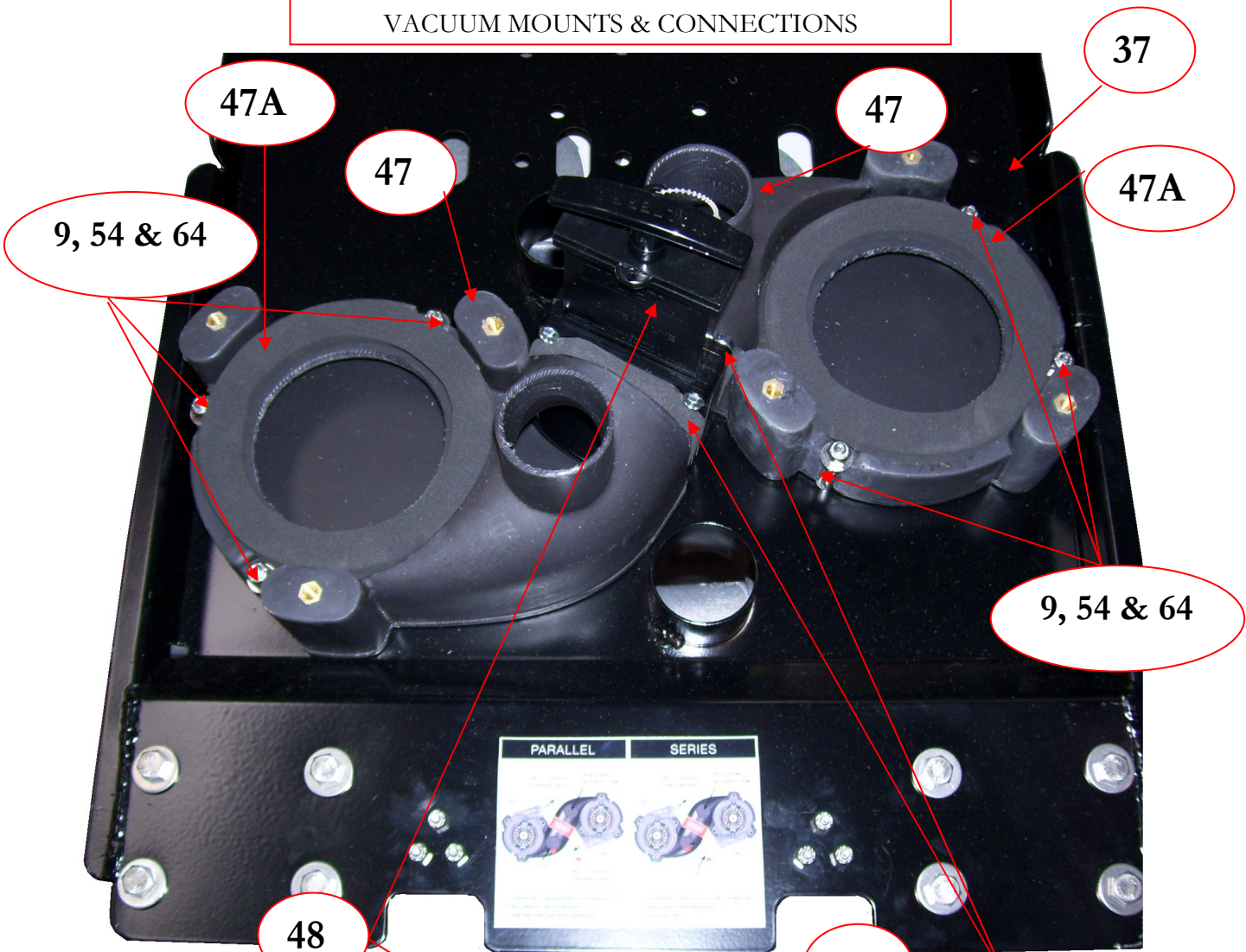

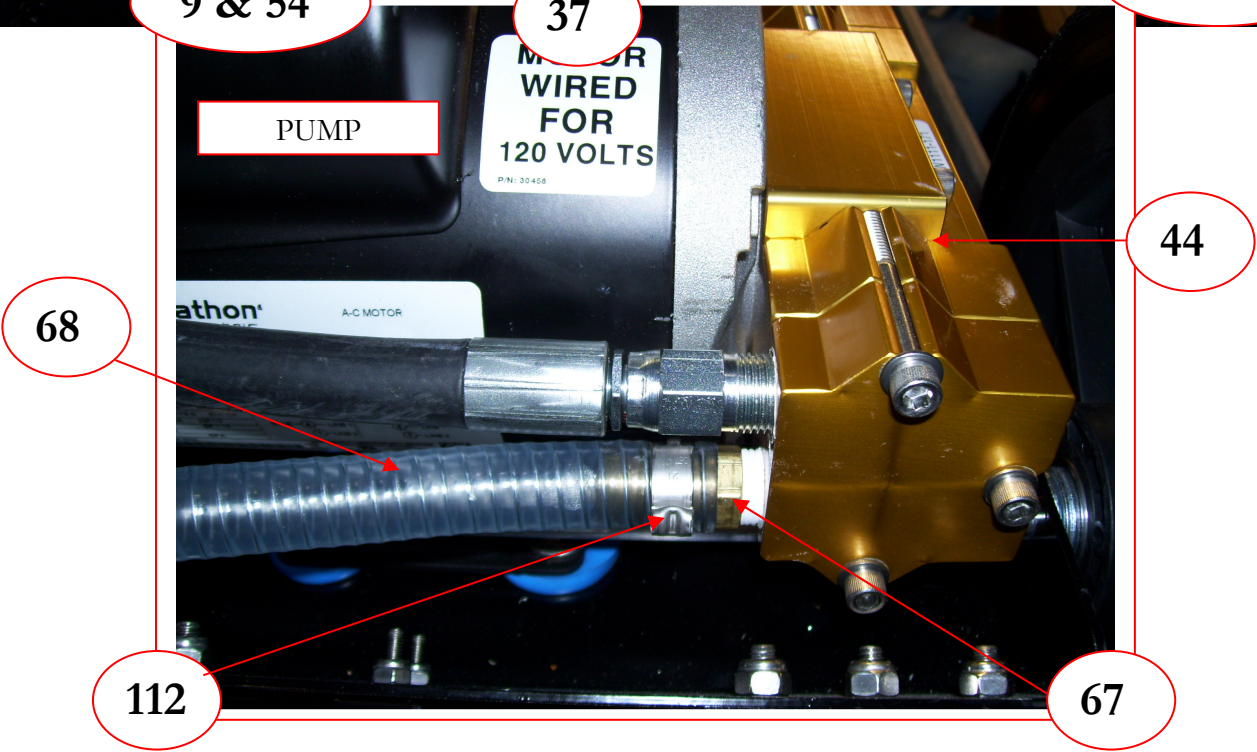
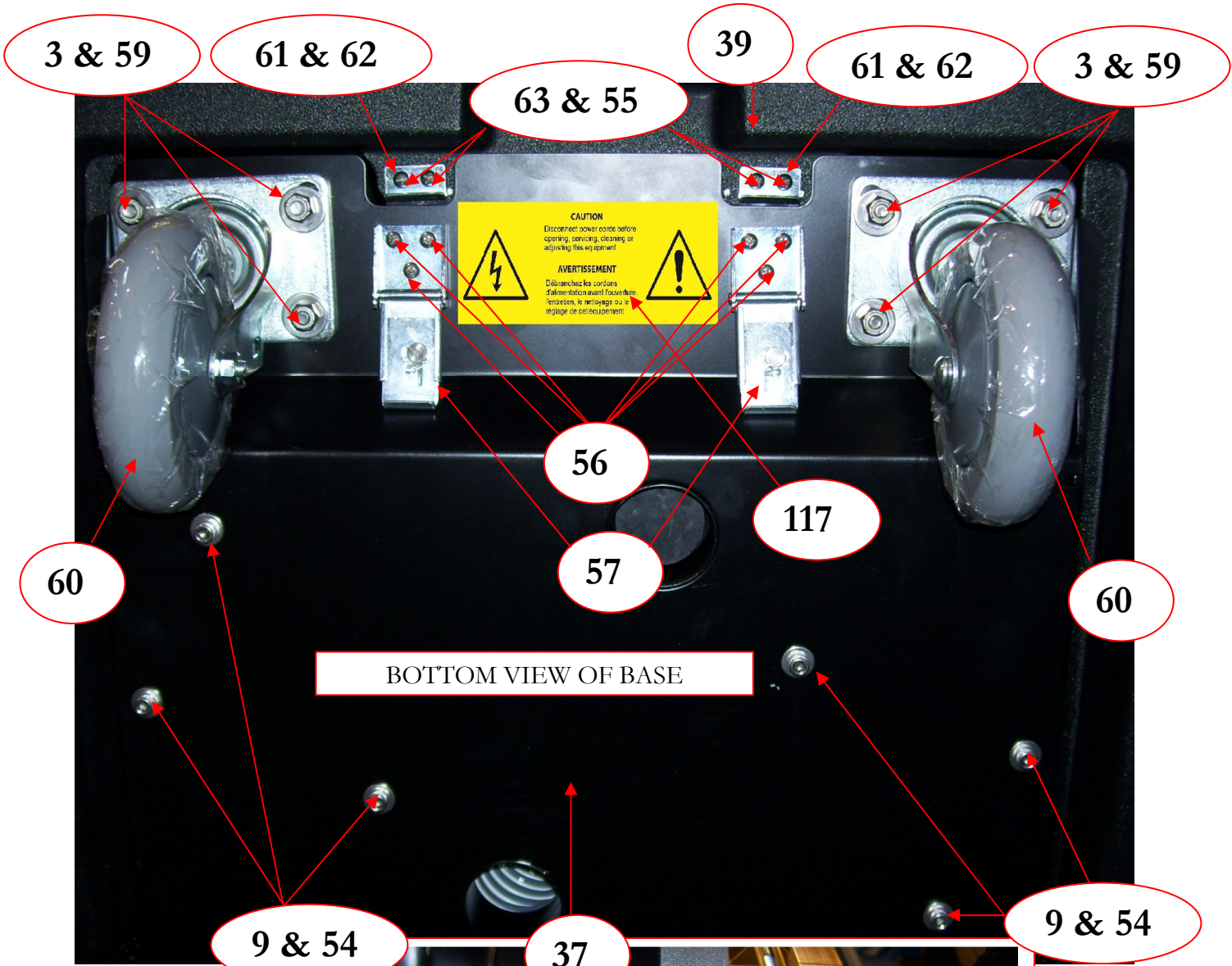

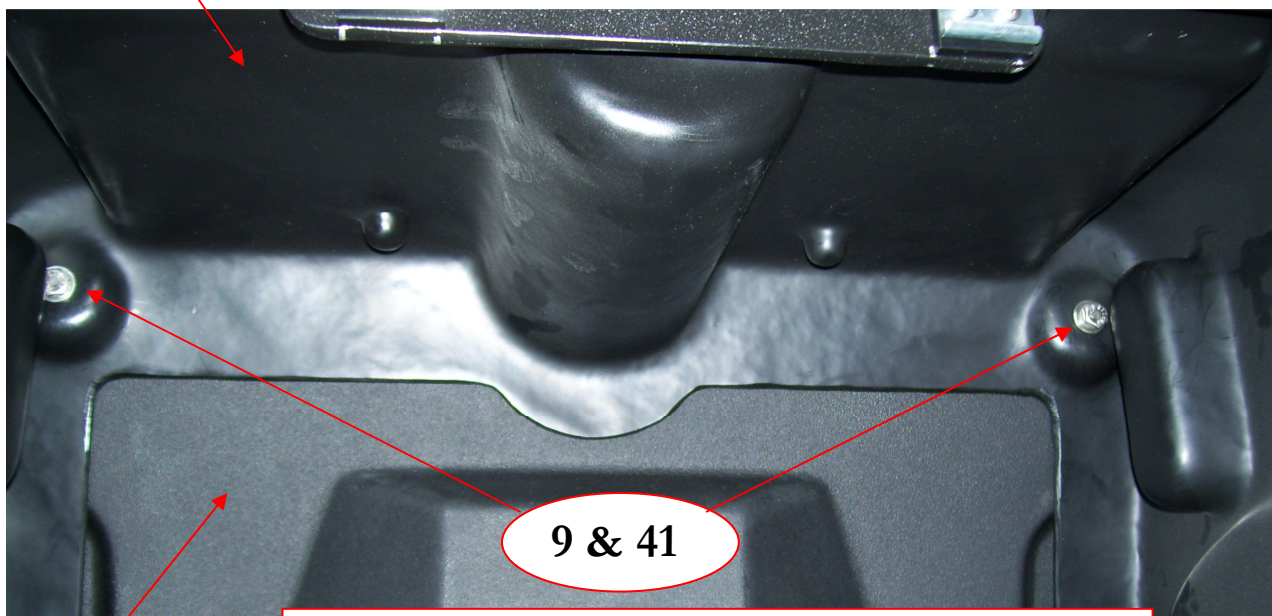
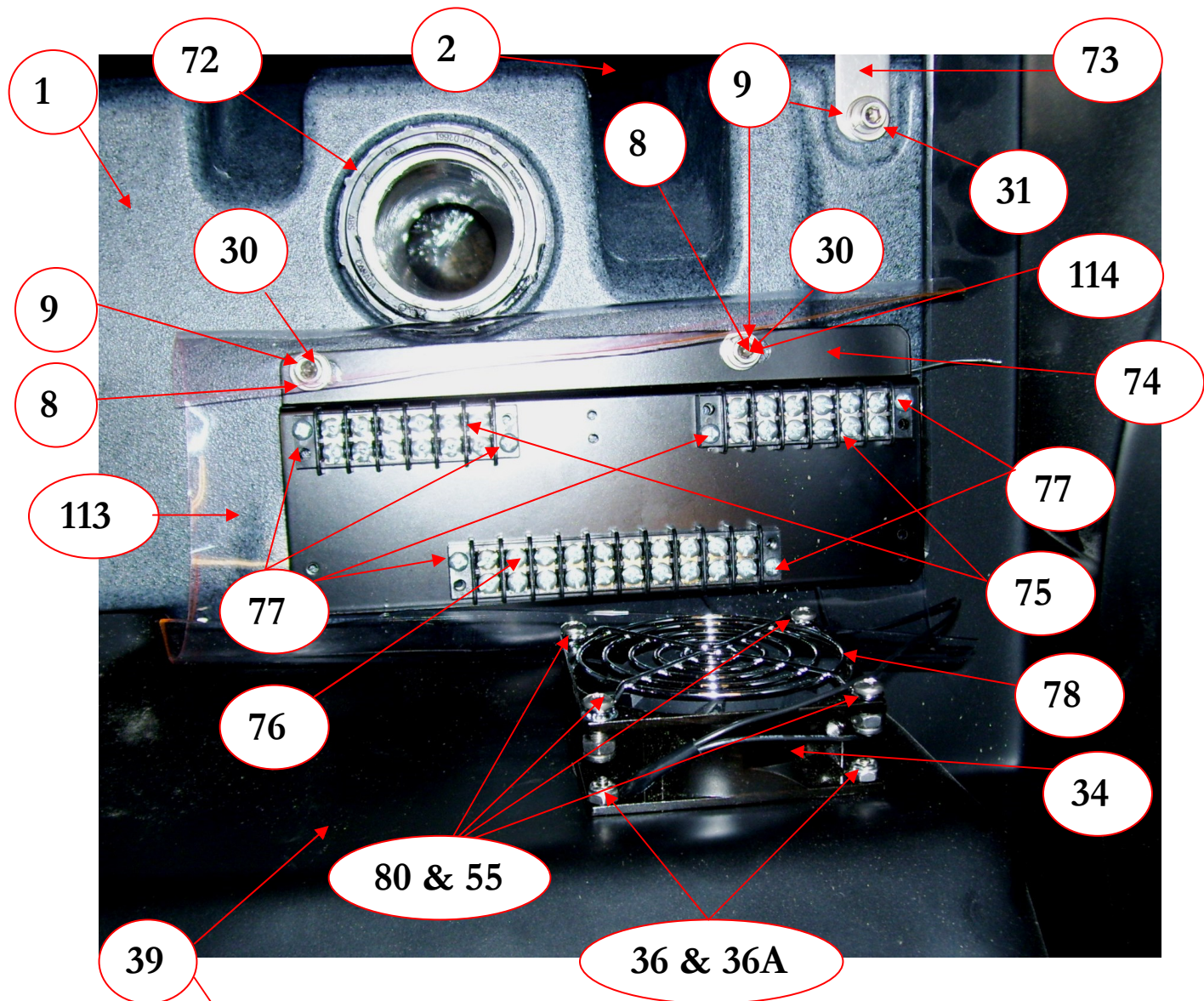

BOTTOM VIEW SOLUTION TANK & BASE SKIRT

2

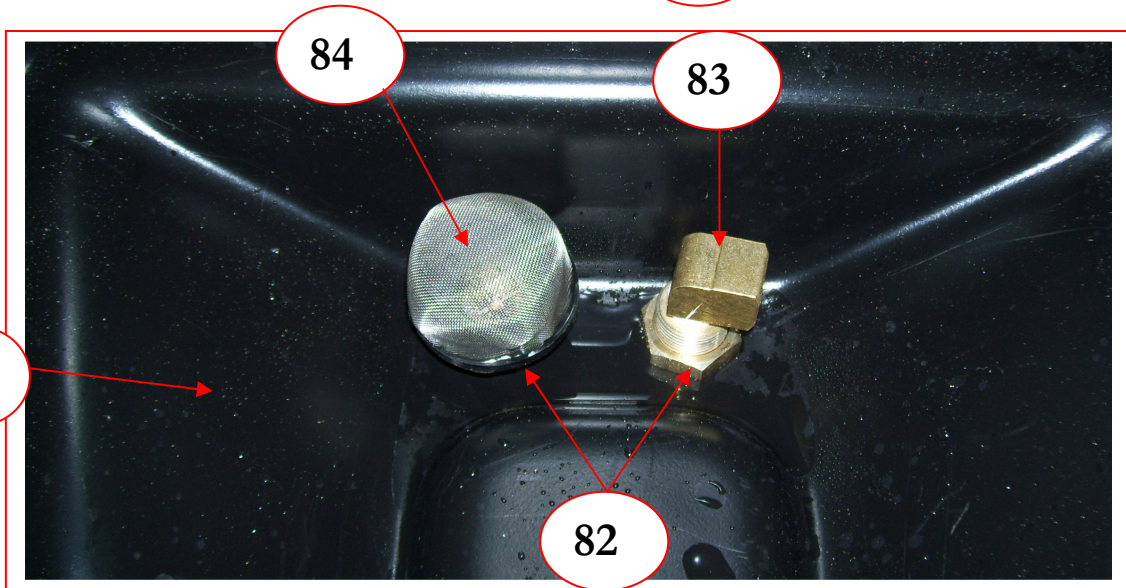
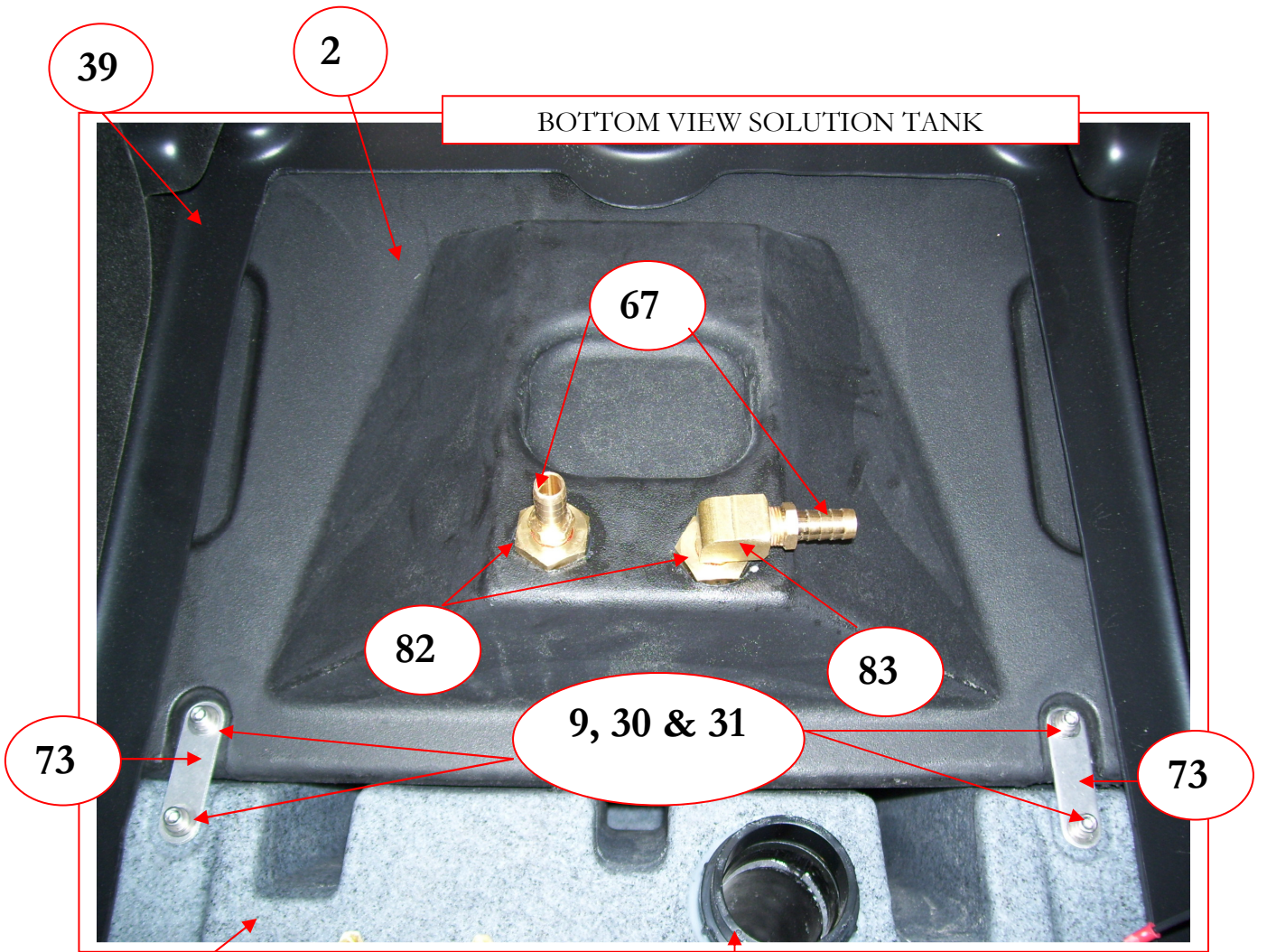

INSIDE SOLUTION TANK

INSIDE RECOVERY TANK
VACUUM SHUTOFF AND OPTIONAL PUMP-OUT
FILTER REMOVED

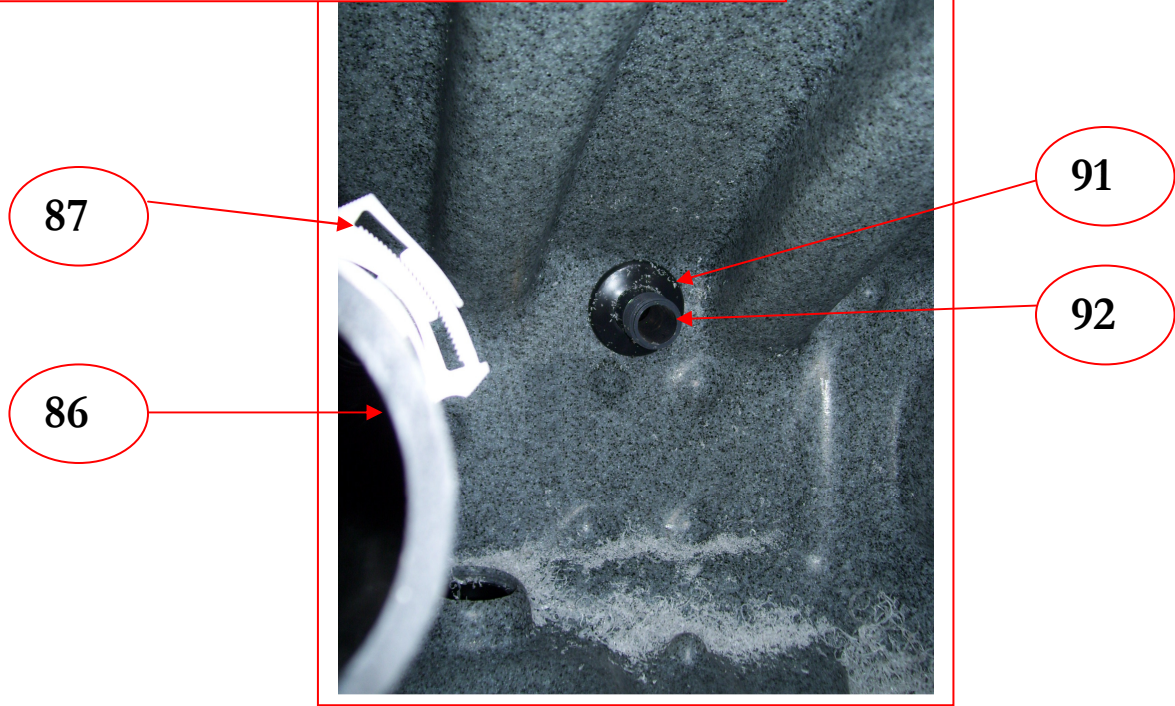

INSIDE RECOVERY TANK
WITH OPTIONAL PUMP-OUT
FILTER IN PLACE

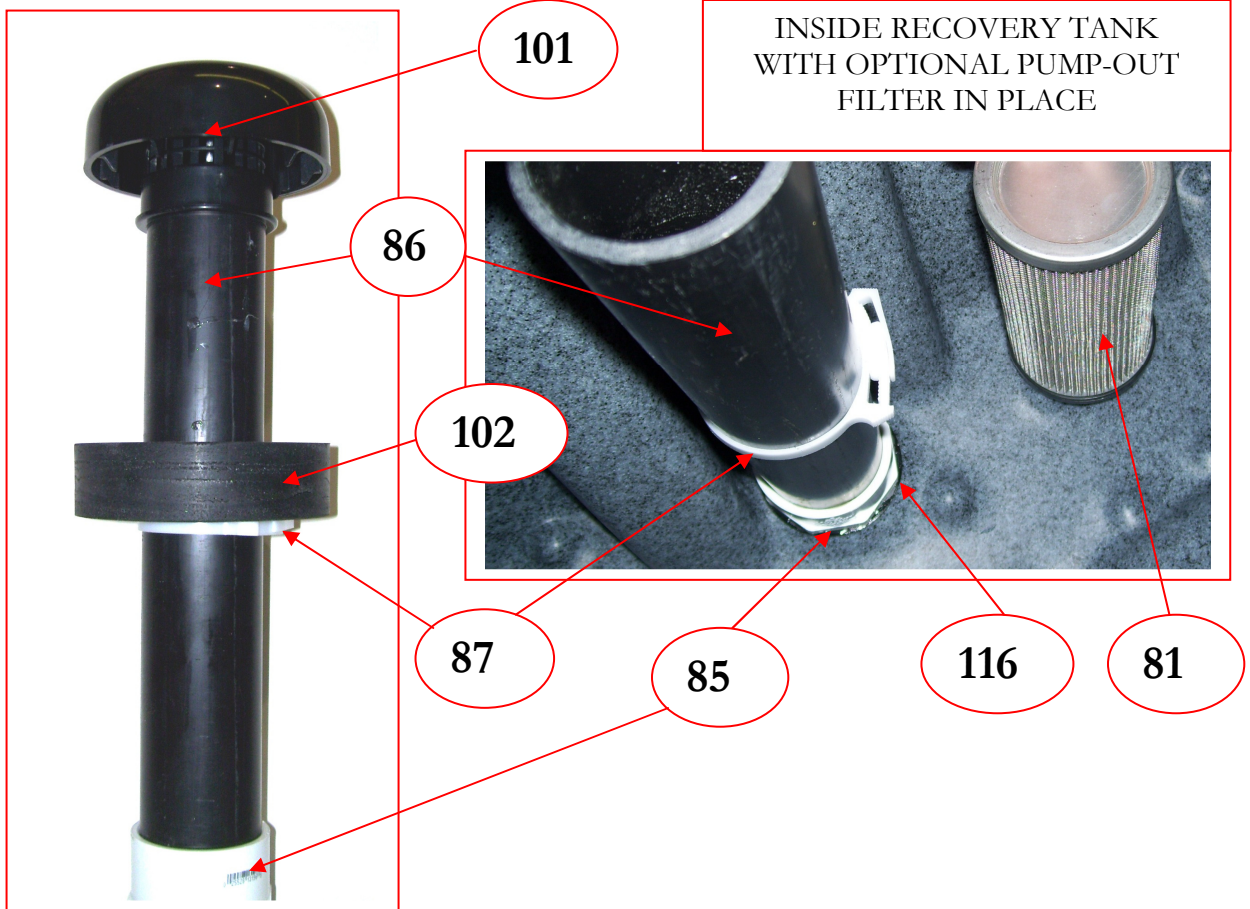

VACUUM SHUTOFF ASSEMBLY

OPTIONAL - PUMP-OUT CONNECTIONS

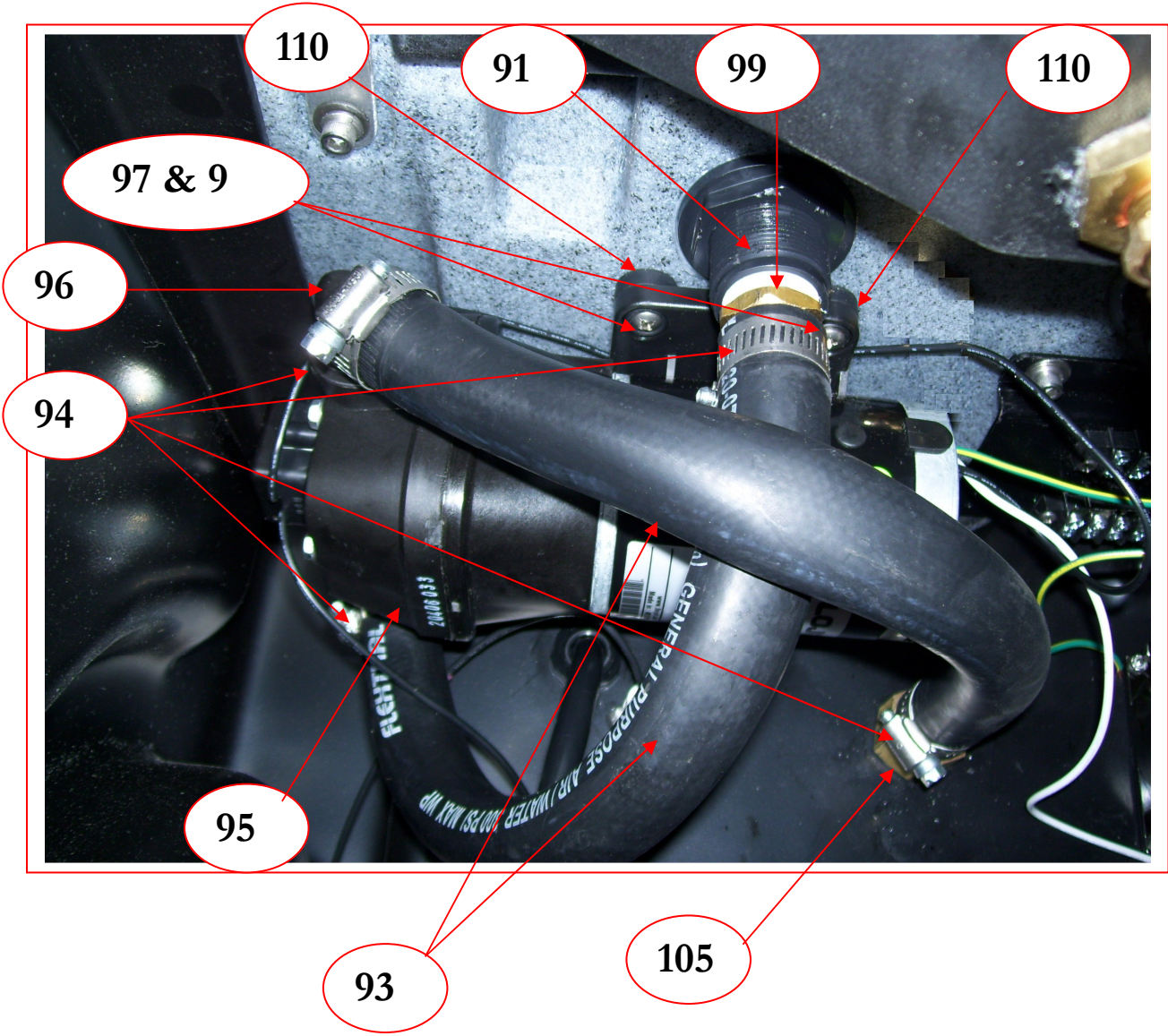

OPTIONAL PUMP-OUT PARTS

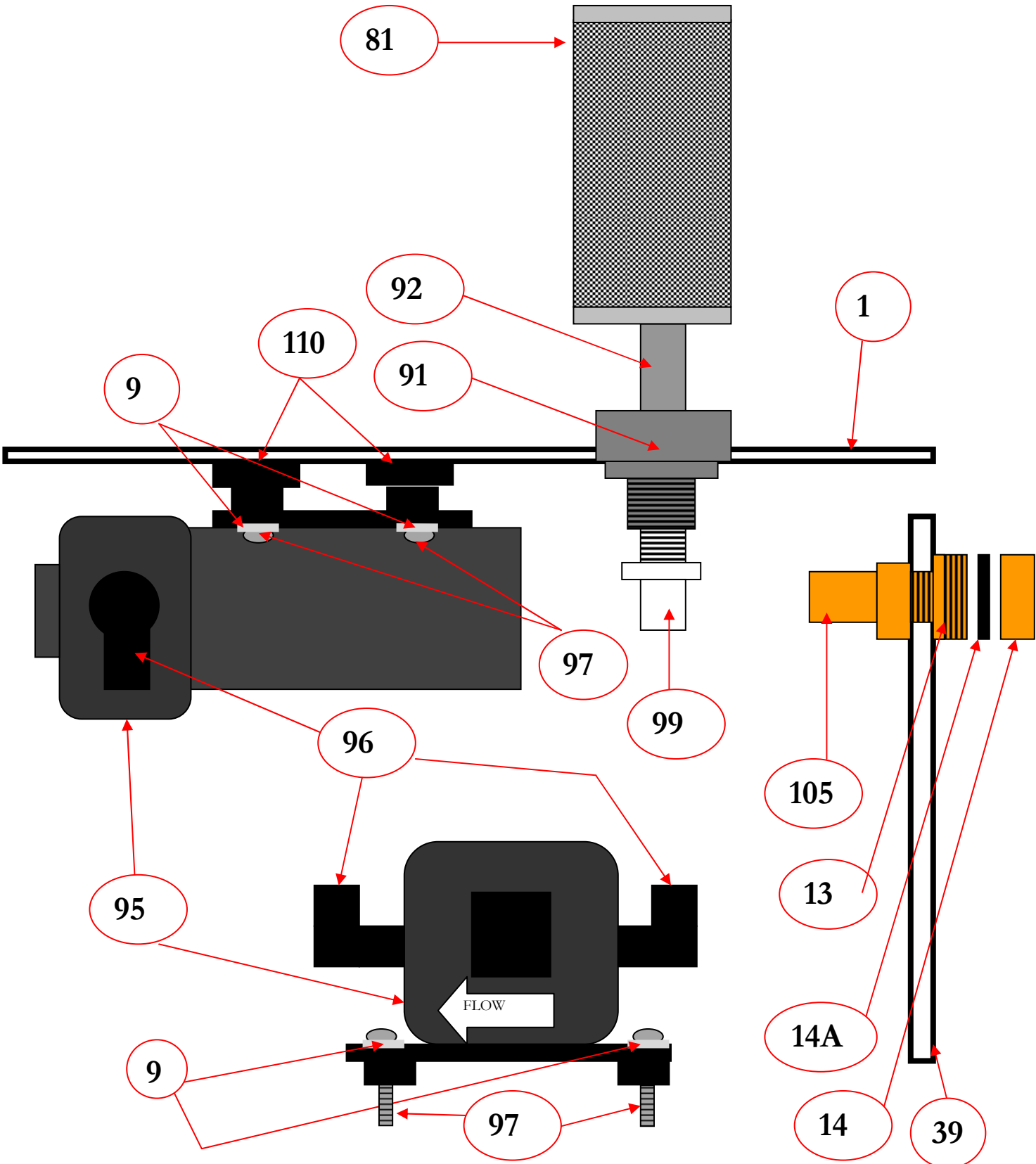

| KEY | PART # | DESCRIPTION | KEY | PART # | DESCRIPTION |
|-----|-----------|---|-----|---------|--|
| 1 | NM5704 | RECOVERY TANK | 21 | AH101B | QUICK CONNECT FEMALE 1/4" |
| 2 | NM5702 | SOLUTION TANK | 22 | BR174 | ADAPTER 1/4" M-F |
| 3 | PFA11 | WASHER 5/16" FLAT SS | 23 | NM5751 | WASHER 1/2" FLAT SS (BEHIND CONTROL PANEL) |
| 4 | NM5724 | WHEEL 2-1/2" GRAY | 23A | NM5751A | WASHER 1/2" FLAT SS WITH NEOPRENE BACKING |
| 5 | NM5143 | ACORN NUT CAP 5/16-18 | 24 | NM5743 | CONTROL PANEL PLATE |
| NS | NM5137 | SCREW 5/16-18 X 2.75" HX SS | 25 | NM5745B | MX500E PANEL DECAL |
| 6 | 1650-5695 | LID ASSY WASTE TANK | 26 | NM5009A | CORD 10AMP W/ PLUG |
| 7 | PA187 | SCREW #10 X 5/8" PH SS(QTY 6) | 27 | NM5038 | CORD STRAIN RELIEF |
| NS | 1663-5397 | GASKET WASTE TANK DECK | 27A | NM5039 | NUT CORD STRAIN RELIEF |
| 8 | NM5028 | SCREW 1/4-20 X1/2" SOCHD SS | 28 | PEA11 | GATE VALVE 1-1/2" MPT |
| 9 | NM5066 | WASHER 1/4" FLAT SS | 29 | NM5759 | CORD WRAP BRACKET (QTY 2) |
| 10 | NM5840 | WAND HOLDER STRAP LONG TOP STRAP | 30 | NM5014 | WASHER 1/4" LOCK SS |
| 11 | NM5844 | WAND HOLDER BUCKLE | 31 | NM4063 | SCREW 1/4-20 X 3/4" SOCHD SS |
| 12 | NM5842 | WAND HOLDER STRAP SHORT BOTTOM STRAP | 32 | NM5722 | WHEEL 12" with HUB CAP |
| 13 | BR319 | ADAPTER 3/4" MPT X 3/4" MGH | NS | NM5010 | AXLE CAP – PUSH NUT |
| 14 | BR325 | GARDEN HOSE CAP | 33 | | |
| 14A | BR600 | GARDEN HOSE WASHER | 34 | NM5754F | COOLING FAN 220/230V |
| NS | AH68 | BARB 2" X 2" MPT PVC | 35 | NM5757 | PLASTIC FAN COVER |
| 15 | AH224 | FLASH CUFF 2" MALE - MPT | 36 | NM5753 | SCREW 6-32 X 3/4" PPH SS(QTY 4) |
| NS | AH201 | FLASH CUFF 2" FEMALE 1.5" | 37 | NM5710A | BASE PLATE ASSEMBLY Comes with Lift Handle & Hinges |
| 16 | NM5714 | ROCKER SWITCH DPST | 38 | NA041 | HANDLE |
| 17 | PT064 | PRESSURE GAUGE 1000PSI | 39 | NM5700 | BASE SKIRT |
| 18 | PT021 | PRESSURE REGULATOR 500PSI | 40 | NM5750 | HINGE (QTY 3) |
| 19 | NM5747 | SCREW 8-32 X1" SOHD SS(QTY 4) | 41 | NM5017 | SCREW 1/4-20 X 3/4" HXHD SS |
| 19A | NM5793 | NUT 8-32 NYLOCK SS (QTY 4) | 41A | NM4261 | NUT 1/4-20 NYLOCK |
| 20 | NM5105 | CIRCUIT BREAKER 5AMP | 42 | NM5947 | SCREW 10-24 x 1/2" PPH SS(QTY 4) |

| KEY | PART # | DESCRIPTION | KEY | PART # | DESCRIPTION |
|-----|------------|--|-----|-------------|------------------------------|
| 42A | PHY094-034 | NUT 10-24 NYLOCK SS(QTY 4) | 67 | BR030 | BARB ½" X 3/8" MPT |
| 43 | NM5748 | AXLE REAR WHEELS – 22.5" | 68 | NM5086 | HOSE ½" ID CLEAR COIL |
| 44 | AP52 | 500PSI PUMP WITH MOTOR | 69 | NM5082 | HOSE 3/8" ID CLEAR COIL |
| 45 | | | 70 | BR020 | BARB 3/8" X ¼" MPT |
| 46 | AV012 | VACUUM MOTOR 2-STAGE 220/230V | 71 | BR272 | ELBOW 45DEG ¼" STREET |
| 47 | NM5706 | VACUUM MANIFOLD | NS | BR282 | ELBOW 90DEG ¼" STREET |
| 47A | PA010A | VACUUM GASKET | 72 | NM5712 | ADAPTER 2" FPT X SPG |
| 48 | NM5728 | GATE VALVE 2" W/ KEEPER | 73 | NM5027 | BRACKET SOL/REC TANK |
| 49 | NM5728A | GASKET VACUUM VALVE | 74 | NM5738 | BRACKET TERMINAL BLOCKS |
| 50 | NM5139 | SCREW ¼-20 X 2.25" SOCHD SS (QTY 6) | 75 | NM5730 | TERMINAL BLOCK 6 SPACE |
| 51 | NM5726 | VACUUM HOSE 2" – PER INCH | 76 | NM5732 | TERMINAL BLOCK 10 SPACE |
| 52 | PA051 | HOSE CLAMP 2-2.75" | 77 | NM5142 | SCREW #6 X ½" PPH SS (QTY 6) |
| 53 | NM5705 | DECAL VAC CONNECTION | 78 | NM5756 | FAN GUARD – WIRE FORMED |
| 54 | NM5133 | SCREW ¼-20 X 2.00" SOCHD SS | 79 | NM4031 | NUT 6-32 NYLOCK SS |
| 55 | NM5793 | NUT 8-32 NYLOCK SS | 80 | NM5124 | SCREW 8-32 X ½" PPH SS |
| 56 | NM5124 | SCREW 8-32 X ½" PPH SS(QTY 6) | 81 | NM5746 | FILTER SS - ¾" FPT |
| 57 | NM5752C | LATCH - SLIDE(QTY 2) | 82 | NM5098 | BULKHEAD FITTING 3/8" |
| 58 | NM5120 | SCREW 5/16-18 X 3/4" HXHD SS | 83 | BR284 | ELBOW 90DEG 3/8" STREET |
| 59 | PFA10 | NUT 5/16-18 NYLOCK SS | 84 | PP14-806504 | ACORN STRAINER ¾" FPT |
| 60 | NM5720 | CASTER 5" (QTY 2) | 85 | NM5727 | ADAPTER 2"MPT X H PVC |
| 61 | NM5752B | LATCH HOOK - KEEPER | 86 | PA029 | PIPE 2" ABS (13.5") |
| 62 | NM5752A | SPACER – LATCH HOOK | 87 | NM5741E | CLAMP NYLON 2-2.5" |
| 63 | NM5128 | SCREW 8-32 X ¾" PPH SS(QTY 4) | 88 | NM4472 | HOSECLAMPW/THUMB SCREW |
| 64 | NM4261 | NUT ¼-20 NYLOCK SS | 89 | | |
| 65 | BR132 | NIPPLE 3/8" X ¼" | 90 | | |
| 66 | BR254 | STREET TEE 3/8" | | | |

| KEY | PART # | DESCRIPTION | KEY | PART # | DESCRIPTION |
|-----|-------------|------------------------------|-----|---------|---|
| 91 | NM5742 | BULKHEAD FITTING ¾" PVC | 117 | NM5705C | DECAL CSA WARNING |
| 92 | NM5744 | NIPPLE ¾" X 2" PVC | NS | NM5025 | RIVET – VAC HOSE END |
| 93 | NM5093 | HOSE ¾" ID CLEAR COIL | NS | NM5713 | ADAPTER 2" FPT X HSLIP ABS |
| 94 | PH09 | HOSE CLAMP | NS | NM5039 | NUT CORD STRAIN RELIEF |
| 95 | AP37F | PUMP-OUT PUMP 220/230V | NS | NM5709 | SPACER UNLOADER MOUNT |
| 96 | PF20381-010 | ELBOW 90 ¾" BARB QUAD FTTG | NS | NM5736 | ISOLATOR – PUMP MOUNT |
| 97 | NM5850 | SCREW 10-24 X 1.25" PPH SS | NS | NM5794 | SCREW 5/16-18 X 1" HXHD SS |
| 98 | NM4255 | WASHER #10 FLAT SS (QTY 4) | NS | NM5792 | WASHER 5/16" FLAT FENDER |
| 99 | BR048P | BARB ¾" X ¾" MPT NYLON | NS | NM5703 | WIRING HARNESS – UPPER #1 |
| 100 | NM5716 | ROCKER SWITCH DUAL SPST | NS | NM5701 | WIRING HARNESS – LOWER #1 |
| 101 | NM5735 | FILTER CAP ASSEMBLY | NS | NM5711 | DECAL NAUTILUS SIDE (QTY 2) |
| 102 | NM5741F | FLOAT VACUUM SHUTOFF | NS | NM4087 | SCREW 1/4-20 x 5/8" SOC BH SS |
| 103 | NM5051 | STRAIN RELIEF WATER TIGHT | NS | NM5731 | EMI FILTER |
| 104 | NM5715 | SWITCH PANEL PLUG | NS | NM5434 | #6 INTERNAL STAR WASHER SS CONTROL PANEL GROUND LUG |
| 105 | BR049 | BARB ¾" X ¾" FPT | NS | | SERIAL NUMBER PLATE WITH FOUR RIVETS |
| 106 | PHY106-028 | RUBBER VACUUM PLUG | NS | NM5933 | 3/16" INT STAR WASHER SS FAN GROUND WIRE CONNECT |
| 107 | NM4263 | SCREW TEK #10 X 5/8" SS | | | |
| 108 | NM4460 | CABLE | | | |
| 109 | NM4462 | SLEEVE #7 CABLE CLAMP | | | |
| 110 | NM4116 | GROMMET 3/8" | | | |
| 111 | BR028 | BARB ½" X ¼" MPT | | | |
| 112 | PH07 | HOSE CLAMP | | | |
| 113 | NM5737 | MOISTURE BARRIER | | | |
| 114 | NM5433 | 1/4" INTERNAL STAR WASHER SS | | | |
| 115 | NM5125 | WASHER ½" FLAT ZINC PL | | | |
| 116 | NM5725 | GASKET VACUUM RISER PIPE | | | |

| DESCRIPTION | HOSE TYPE | LENGTH | NOTES |
|---|---|--------------------|---|
| VAC HOSE REC TANK TO MANIFOLD | 2" VAC – NM5726 SOLD PER FT | 29" | TANK END: 1 - NM5713 2 – NM5025 VAC END: HOSE CLAMP PA051 |
| VAC HOSE VAC 1 TO MANIFOLD | 2" VAC – NM5726 SOLD PER FT | 9.5" | VAC END: HOSE CLAMP PA051 MANIFOLD END HOSE CLAMP NM4472 |
| VAC HOSE VAC 2 TO BASE | 2" VAC – NM5726 SOLD PER FT | 9.5" | BOTH ENDS: HOSE CLAMP PA051 |
| SOLUTION HOSE SOL TANK TO PUMP TEE FITTING | ½" ID CLEAR COIL NM5086 SOLD PER INCH | 18" | BOTH ENDS: HOSE CLAMP PH07 |
| SOLUTION HOSE PUMP TO PUMP TEE FITTING | ½" ID CLEAR COIL NM5086 SOLD PER INCH | 12" (QTY 2) | BOTH ENDS: HOSE CLAMP PH07 |
| SOLUTION HOSE UNLOADER TO SOL TANK | ½" ID CLEAR COIL NM5086 SOLD PER INCH | 32" | BOTH ENDS: HOSE CLAMP PH07 |
| HP HOSE #1 PUMP TO REGULATOR | HP PULSE SOLD ASSEMBLED | 50" ITEM# 30844 | REG END: ¼" MS PUMP END: 3/8" MS |
| HP HOSE #2 PUMP TO GAUGE | HP PULSE SOLD ASSEMBLED | 45" ITEM# PH509 | GAUGE END: ¼" MS PUMP END: 3/8" MS |
| HP HOSE #3 REGULATOR TO HP HOSE #4 | HP PULSE SOLD ASSEMBLED | 32" ITEM# 30845 | BOTH ENDS: 1/4" MS |
| HP HOSE #4 OUTLET QC TO HP HOSE #3 | ¼" HP HYDROCOIL AH79CF SOLD PER FT | 39" | QC END: XAF1 (M) * JOINT END: XAF2 (FM) |
| DRAIN HOSE REC TANK TO PUMP-OUT PUMP | ¾" CLEAR COIL NM5093 SOLD PER INCH | 14" | BOTH ENDS: HOSE CLAMP PH09 |
| DRAIN HOSE PUMP-OUT PUMP TO PUMP-OUT OUTLET FITTING | ¾" CLEAR COIL NM5093 SOLD PER INCH | 13" | BOTH ENDS: HOSE CLAMP PH09 |

* FITTINGS ADDED BETWEEN HOSE #4 AND CONTROL PANEL:
(1) NM5751, (2) BR174 & (1) BR282

Limited Warranty

Section

4

Your Nautilus MX500E is designed to give you years of reliable service. If a problem should arise use the troubleshooting section in the operation manual to diagnose and correct the problem if possible.

If you are unable to determine the cause or solution to the problem contact your distributor or Hydro-Force for assistance.

Hydro-Force warrants the roto-molded tanks and base of the Nautilus MX500E to be free from defects in material or workmanship for five years from the date of purchase.

All other components of the Nautilus MX500E are warranted to be free of defects in material and workmanship for one year from the date of purchase.

During the warranty period, Hydro-Force will, at its option, repair or replace components which prove to be defective. This warranty does not provide for replacement of complete units due to defective components. Any costs for transportation or related service labor are not covered in this warranty. Replacement parts are warranted only for the remainder of the original warranty period.

This warranty shall not apply to defects resulting from improper operation, lack of maintenance, unauthorized modification, chemical incompatibility, misuse, abuse or exposure to freezing temperature conditions. It does not cover normal wear items such as o-rings, valve seals, pump seals, hoses, jets, cords, batteries, or other items which require replacement as a result of ordinary usage.

To obtain warranty service for the Nautilus MX500E, contact your distributor or Hydro-Force. If the extractor must be returned to Hydro-Force or an authorized service center, the purchaser shall prepay shipping charges for products returned for warranty service. No returned items will be accepted by Hydro-Force without prior authorization. All returns must have a return authorization number, issued by Hydro-Force, clearly marked on the exterior of the package.

Hydro-Force makes no other warranty either expressed or implied with respect to this product.

The remedies provided herein are the purchaser's sole and exclusive remedies. In no event shall Hydro-Force be liable for any direct, indirect, special, incidental or consequential damages.

This warranty gives you specific legal rights. You may also have other rights which vary from jurisdiction to jurisdiction.